

# FAB10LOR5



Product Family	Refrigerator
Installation	Free standing
Category	One Door
Reference width	Until 60 cm
Reference height	Until 100 cm
Cooling type	Static
Defrost	Automatic for refrigerator, manual for freezer
Hinge type	Standard
Hinge position	Left
EAN code	8017709298791



## Aesthetics

Aesthetic	50's Style	Handle colour	Chrome
Colour	Orange	Logo colour	Chrome
Design	Rounded	Side material	Steel
Finishing	Glossy	Side colour	Orange
Material	Heat-moulded	Logo	Applied
Handle	External	Door shelves profile color	Silver
Handle type	Fixed	Color of glass shelf profile	Silver

## Refrigerator compartment features



Number of compartments	1	Type of crisper/vegetable drawers cover	Standard
Compartment types	Fruit and vegetable compartment	Crisper Cover	Yes
No. of adjustable shelves	1	Type of crisper/vegetable drawers cover	Glass
Number of fruit and vegetables drawers	1	Internal light in fridge	Yes
Shelves material	Glass	Type of internal light (fridge)	LED

## Refrigerator Inner Door

No. of bottle shelves	1
-----------------------	---

Number of adjustable door shelves 2

## Freezer compartment features

Internal freezer compartment Yes

## Other technical features

Type of temperature control	Electro-mechanical
No. of compressors	1
Refrigerant gas type	R600a
Type of compressor	Standard
Refrigerant Quantity (g)	25 g
Foam agent	Cyclopentane

## Performance / Energy Label - Reg. 2019

			
Annual energy consumption	142 kWh/a	Airborne acoustical noise emissions	37 dB(A) re 1 pW
Energy efficiency class	E	Temperature Rise Time	9 h
Airborne acoustical noise emission class	C	4 star - Freezing capacity	2,6 kg/24h
Total net volume	122 l	Climate class	SN, N, ST, T
Sum of the volumes of the frozen compartment(s)	17 l	EEl	98 %
Sum of the volumes of the chill compartment(s) and the unfrozen compartment(s)	105 l		

## Electrical Connection

Electrical connection rating	50 W	Frequency (Hz)	50 Hz
Current	0,42 A	Power supply cable length	180 cm
Voltage (V)	220-240 V	Plug	(F;E) Schuko

## Logistic Information

Width	545 mm	Product width with maximum doors opening	842 mm
Depth without handle	659 mm	Product depth with handle	701 mm
Height	970 mm		

Product depth with  
doors open at 90°

1085 mm

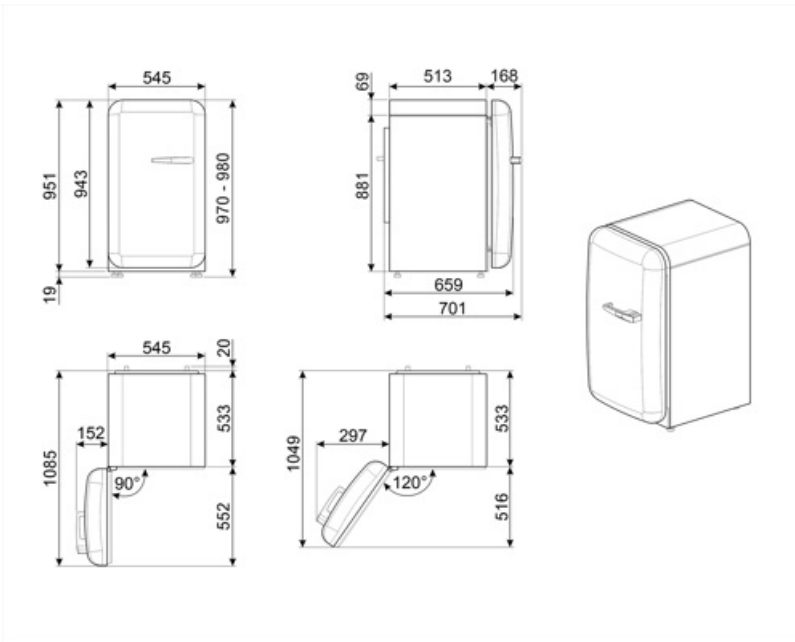

---

## Alternative products

---



**FAB10LWH5**

**Hinge position: Left**  
White



**FAB10LCR5**

**Hinge position: Left**  
Cream



**FAB10LBL5**

**Hinge position: Left**  
Black







**FAB10LRD5**

**Hinge position: Left**  
Red

---

## Symbols glossary

---

- |  |  |
|--|--|
|  <p>4 stars freezing compartment for better food preservation.</p>   |  <p>The automatic defrost system works by automatically defrosting at regular intervals eliminating the need to defrost altogether.</p> |
|  <p>A++: Energy efficiency class A++ helps to save up to 20% energy compared to class A. Maximum performance with minimum consumption is guaranteed.</p> |  <p>LED interior lighting: is a more energy efficient and long lasting way of illuminating the interior of the appliance.</p>           |
|  <p>Energy efficiency class E</p>  |  |