

FAB10RBL5



Product Family	Refrigerator
Installation	Free Standing
Category	One Door
Reference width	Until 60
Reference height	Until 100
Cooling type	Static
Defrost	Automatic for refrigerator, manual for freezer
Hinge type	Standard
Door opening flush with the wall	No
Slot-in	No
Hinge position	Right
Reversible door	No
EAN code	8017709298821



Aesthetics

Aesthetic	Estilo anos '50	Side material	Steel
Colour	Black	Side colour	Black
Acabamento	Brilhante	Logotipo	Logotipo aplicado
Design	Rounded	Cor do perfil das prateleiras da porta	Silver
Material	Heat-moulded	Cor do perfil da prateleira de vidro	Silver
Handle kit to be ordered separately	No	Display	No
Handle	External	Dispenser	No
Handle type	Fixed	Water Filter	No
Handle colour	Chrome	HomeBar	No
Logo colour	Chrome		

Refrigerator compartment features



No. of adjustable shelves	1	Type of crisper/vegetable drawers cover	Glass
Number of fruit and vegetables drawers	1	Life Plus zone-0°C	No
Type of adjustable shelves	Glass	Compartimento baixa temperatura	No
Type of crisper/vegetable drawers cover	Standard	Internal light in fridge	Yes
Crisper Cover	Yes	Type of internal light (fridge)	LED
Bottle shelf	No		

Refrigerator Inner Door

Number of adjustable door shelves	2	No. of bottle shelves	1
-----------------------------------	---	-----------------------	---

Other Refrigerator features

Natural Plus Blu Light	No	Tecnologia de titânio	No
MultiFlow	No	Filtro de odor antibacteriano	No
Fan	No	Zona de cuidados biológicos	No
Ionizer	No		

Freezer compartment features

Internal freezer compartment	Yes	Internal light in freezer	No
------------------------------	-----	---------------------------	----

Other technical features



Ligação à rede de água	No
Power on lamp	No
Temperature alarm lamp	No
Door open alarm	No
Temperature Alarm	No
Antibacterial Gasket	Yes
Type of temperature control	Electro-mechanical
No. of compressors	1
Refrigerant gas type	R600a
Type of compressor	Standard
Refrigerant Quantity (gr)	25 g
Espuma expansiva de isolamento	Ciclopentano

Etiqueta de Desempenho / Energia - Reg. 2019



Consumo de energia anual	142 kWh/a	Airborne acoustical noise emissions	37 dB(A) re 1 pW
Classe de eficiência energética	E	Autonomia de conservação sem energia elétrica	9 h
Classe de emissão de ruído acústico aerotransportado	C	4 estrelas - Capacidade de congelamento	2.6 Kg/24h
Volume líquido total	122 l	Classe climática	SN, N, ST, T
		EEl	98 %

Soma dos volumes do(s) 17 l
compartimento(s)
congelado(s)

Soma dos volumes do(s) 105 l
compartimento(s)
refrigerado(s) e do(s)
compartimento(s) não
congelado(s)

Electrical Connection

Plug	(F;E) Schuko	Voltage (V)	220-240 V
Electrical connection rating	50 W	Frequency (Hz)	50 Hz
Current	0,42 A	Power supply cable length	180 cm

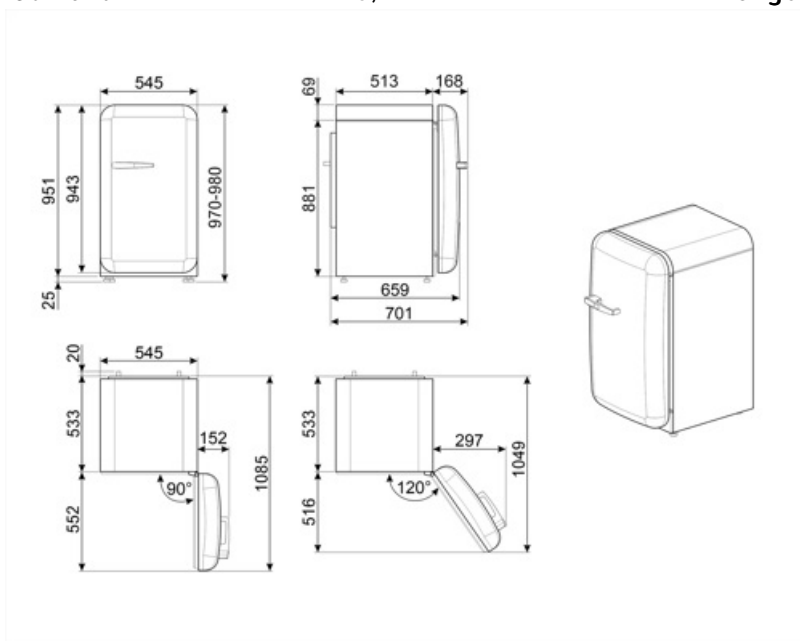

Alternative products



FAB10RPK5

Hinge position: Right
Pink



FAB10RCR5

Hinge position: Right
Cream



FAB10RWH5

Hinge position: Right
White



FAB10RPB5

Hinge position: Right
Pastel blue



FAB10RRD5

Hinge position: Right
Red



FAB10ROR5

Hinge position: Right
Orange



FAB10RDUJ5







Hinge position: Right
Decorated / Special



FAB10RPG5

Hinge position: Right
Pastel green

Symbols glossary

- | | | | |
|--|--|---|--|
|  | Compartimento de congelamento de 4 estrelas para uma melhor preservação dos alimentos. |  | O sistema de descongelamento automático funciona descongelando automaticamente em intervalos regulares, eliminando a necessidade de descongelar completamente. |
|  | Tratamento antibacteriano: tratamento antibacteriano para garantir uma melhor higiene |  | A++: A classe de eficiência energética A++ ajuda a economizar até 20% de energia em comparação com a classe A. O desempenho máximo com consumo mínimo é garantido. |
|  | Classe de eficiência energética E. |  | Iluminação interior LED: é uma forma mais eficiente em termos energéticos e duradoura de iluminar o interior do aparelho. |

Benefit (TT)

Refrigerant gas R600a

Environmentally friendly R600a refrigerant gas contributes to rapid cooling with lower energy consumption

Climate class

Climatic class SN-T makes the appliance suitable for working at room temperature between 10 °C and 43 °C (50 °F ~ 109 °F)

External handle

The external handle ensures practicality and ease of use of the refrigerator

Refrigerator Internal lighting

Interior lighting for perfect visibility of shelves in the refrigerator compartment

Fruit and vegetable drawer

The fruit and vegetable drawer ensures the best storage conditions for fresh food, avoiding any contamination