

# FAB10RDLM5

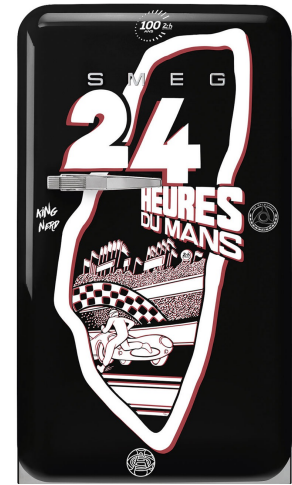

Product Family	Refrigerator
Installation	Free Standing
Category	One Door
Reference width	Until 60
Reference height	Until 100
Cooling type	Static
Defrost	Automatic for refrigerator, manual for freezer
Hinge type	Standard
Door opening flush with the wall	No
Slot-in	No
Hinge position	Right
Reversible door	No
EAN code	8017709333591



## Aesthetics

Aesthetic	Estilo anos '50	Logo colour	Chrome
Colour	Decorated / Special	Side material	Steel
Acabamento	Brilhante	Side colour	Decorated / Special
Decoration / Special colour	Le Mans	Logotipo	Logotipo aplicado
Design	Rounded	Cor do perfil das prateleiras da porta	Silver
Material	Heat-moulded	Cor do perfil da prateleira de vidro	Silver
Handle kit to be ordered separately	No	Display	No
Handle	External	Dispenser	No
Handle type	Fixed	Water Filter	No
Handle colour	Chrome	HomeBar	No

## Refrigerator compartment features



No. of adjustable shelves	1	Type of crisper/vegetable drawers cover	Glass
Number of fruit and vegetables drawers	1	Life Plus zone-0°C	No
Type of adjustable shelves	Glass	Compartimento baixa temperatura	No
Type of crisper/vegetable drawers cover	Standard	Internal light in fridge	Yes
Crisper Cover	Yes	Type of internal light (fridge)	LED
Bottle shelf	No		

## Refrigerator Inner Door

Number of adjustable door shelves	2	No. of bottle shelves	1
Adjustable door shelves with wire support	No	Bottle shelves with wire support	No

## Other Refrigerator features

Natural Plus Blu Light	No	Tecnologia de titânio	No
MultiFlow	No	Filtro de odor antibacteriano	No
Fan	No	Zona de cuidados biológicos	No
Ionizer	No		

## Freezer compartment features

Internal freezer compartment	Yes	Type of internal light (freezer)	No
Internal light in freezer	No		

## Other technical features

Ligação à rede de água	No
Power on lamp	No
Temperature alarm lamp	No
Door open alarm	No
Temperature Alarm	No
Type of temperature control	Electro-mechanical
No. of compressors	1
Refrigerant gas type	R600a
Type of compressor	Standard
Refrigerant Quantity (gr)	25 g
Espuma expansiva de isolamento	Ciclopentano

## Etiqueta de Desempenho / Energia - Reg. 2019

 Consumo de energia anual	142 kWh/a	Airborne acoustical noise emissions	37 dB(A) re 1 pW
Classe de eficiência energética	E	Autonomia de conservação sem energia elétrica	9 h
Classe de emissão de ruído acústico aerotransportado	C	4 estrelas - Capacidade de congelamento	2.6 Kg/24h
Volume líquido total	122 l	Classe climática	SN, N, ST, T
		EI	98 %

Soma dos volumes do(s) 17 l  
compartimento(s)  
congelado(s)



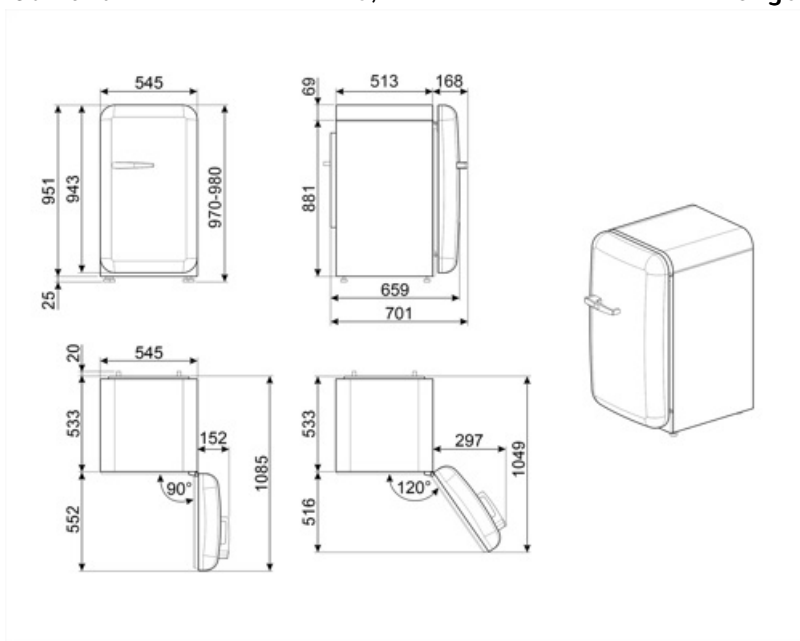

Soma dos volumes do(s) 105 l  
compartimento(s)  
refrigerado(s) e do(s)  
compartimento(s) não  
congelado(s)

## Electrical Connection

Plug	(F;E) Schuko	Voltage (V)	220-240 V
Electrical connection rating	50 W	Frequency (Hz)	50 Hz
Current	0,42 A	Power supply cable length	180 cm



## Symbols glossary

-  Compartimento de congelamento de 4 estrelas para uma melhor preservação dos alimentos.
-  A++: A classe de eficiência energética A++ ajuda a economizar até 20% de energia em comparação com a classe A. O desempenho máximo com consumo mínimo é garantido.
-  Iluminação interior LED: é uma forma mais eficiente em termos energéticos e duradoura de iluminar o interior do aparelho.
-  O sistema de descongelamento automático funciona descongelando automaticamente em intervalos regulares, eliminando a necessidade de descongelar completamente.
-  Classe de eficiência energética E.

---

## Benefit (TT)

---

### **Refrigerant gas R600a**

Environmentally friendly R600a refrigerant gas contributes to rapid cooling with lower energy consumption

### **Climate class**

Climatic class SN-T makes the appliance suitable for working at room temperature between 10 °C and 43 °C (50 °F ~ 109 °F)

### **External handle**

The external handle ensures practicality and ease of use of the refrigerator

### **Refrigerator Internal lighting**

Interior lighting for perfect visibility of shelves in the refrigerator compartment

### **Fruit and vegetable drawer**

The fruit and vegetable drawer ensures the best storage conditions for fresh food, avoiding any contamination