

FAB10RPG5



| | |
|------------------|--|
| Product Family | Refrigerator |
| Installation | Free standing |
| Category | One Door |
| Reference width | Until 60 cm |
| Reference height | Until 100 cm |
| Cooling type | Static |
| Defrost | Automatic for refrigerator, manual for freezer |
| Hinge type | Standard |
| Hinge position | Right |
| EAN code | 8017709298876 |



Aesthetics

| | | | |
|-------------|--------------|------------------------------|--------------|
| Aesthetic | 50's Style | Handle colour | Chrome |
| Colour | Pastel green | Logo colour | Chrome |
| Design | Rounded | Side material | Steel |
| Finishing | Glossy | Side colour | Pastel green |
| Material | Heat-moulded | Logo | Applied |
| Handle | External | Door shelves profile color | Silver |
| Handle type | Fixed | Color of glass shelf profile | Silver |

Refrigerator compartment features



| | | | |
|--|---------------------------------|---|----------|
| Number of compartments | 1 | Type of crisper/vegetable drawers cover | Standard |
| Compartment types | Fruit and vegetable compartment | Crisper Cover | Yes |
| No. of adjustable shelves | 1 | Type of crisper/vegetable drawers cover | Glass |
| Number of fruit and vegetables drawers | 1 | Internal light in fridge | Yes |
| Shelves material | Glass | Type of internal light (fridge) | LED |

Refrigerator Inner Door

| | |
|-----------------------|---|
| No. of bottle shelves | 1 |
|-----------------------|---|

Number of adjustable door shelves 2

Freezer compartment features

Internal freezer compartment Yes

Other technical features

| | |
|-----------------------------|--------------------|
| Type of temperature control | Electro-mechanical |
| No. of compressors | 1 |
| Refrigerant gas type | R600a |
| Type of compressor | Standard |
| Refrigerant Quantity (g) | 25 g |
| Foam agent | Cyclopentane |

Performance / Energy Label - Reg. 2019

| | | | |
|--|-----------|-------------------------------------|------------------|
|  | | | |
| Annual energy consumption | 142 kWh/a | Airborne acoustical noise emissions | 37 dB(A) re 1 pW |
| Energy efficiency class | E | Temperature Rise Time | 9 h |
| Airborne acoustical noise emission class | C | 4 star - Freezing capacity | 2,6 kg/24h |
| Total net volume | 122 l | Climate class | SN, N, ST, T |
| Sum of the volumes of the frozen compartment(s) | 17 l | EEI | 98 % |
| Sum of the volumes of the chill compartment(s) and the unfrozen compartment(s) | 105 l | | |

Electrical Connection

| | | | |
|------------------------------|-----------|---------------------------|--------------|
| Electrical connection rating | 50 W | Frequency (Hz) | 50 Hz |
| Current | 0,42 A | Power supply cable length | 180 cm |
| Voltage (V) | 220-240 V | Plug | (F;E) Schuko |

Logistic Information

| | | | |
|----------------------|--------|--|--------|
| Width | 545 mm | Product width with maximum doors opening | 842 mm |
| Depth without handle | 659 mm | Product depth with handle | 701 mm |
| Height | 970 mm | | |

Product depth with
doors open at 90°

1085 mm

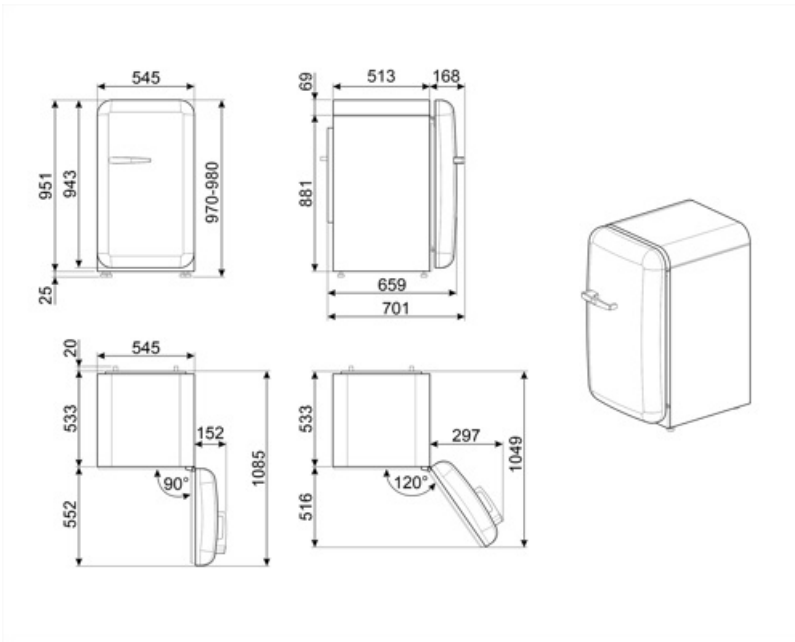

Alternative products



FAB10RPK5

Hinge position: Right
Pink



FAB10RCR5

Hinge position: Right
Cream



FAB10RWH5

Hinge position: Right
White



FAB10RPB5

Hinge position: Right
Pastel blue



FAB10RRD5

Hinge position: Right
Red



FAB10ROR5

Hinge position: Right
Orange



FAB10RDUJ5





Hinge position: Right
Decorated / Special



FAB10RBL5

Hinge position: Right
Black

Symbols glossary

- | | | | |
|--|--|---|---|
|  | 4 stars freezing compartment for better food preservation. |  | The automatic defrost system works by automatically defrosting at regular intervals eliminating the need to defrost altogether. |
|  | A++: Energy efficiency class A++ helps to save up to 20% energy compared to class A. Maximum performance with minimum consumption is guaranteed. |  | Energy efficiency class E |
|  | LED interior lighting: is a more energy efficient and long lasting way of illuminating the interior of the appliance. | | |