

# FAB28LBL5



Product Family	Refrigerator
Installation	Free standing
Category	One Door
Reference width	Until 60
Reference height	100 - 160
Cooling type	Fan assisted refrigerator, static freezer
Defrost	Automatic for refrigerator, manual for freezer
Hinge type	Standard
Hinge position	Left
EAN code	8017709298715



## Aesthetics

Colour	Black	Logo colour	Chrome
Finishing	Glossy	Side material	Steel
Aesthetics	50's Style	Side colour	Black
Design	Rounded	Logo	Applied
Material	Heat-moulded	Door shelves profile color	Chrome
Handle	External	Drawers profile color	Chrome
Handle type	Fixed	Color of glass shelf profile	Chrome
Handle colour	Chrome		

## Refrigerator compartment features



No. of adjustable shelves	2	Type of crisper/vegetable drawers cover	Glass
Number of fruit and vegetables drawers	1	Life Plus zone-0°C	Yes
Type of adjustable shelves	Glass	Internal light in fridge	Yes
Type of crisper/vegetable drawers cover	On sliding rails	Type of internal light (fridge)	LED
Crisper Cover	Yes		

## Refrigerator Inner Door

No. of bottle shelves	1
-----------------------	---

No. of door shelves with transparent cover	1	Bottle shelves with wire support	Yes
Number of adjustable door shelves	1		
Adjustable door shelves with wire support	Yes		

## Other Refrigerator features

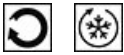

MultiFlow

Yes

Fan

Yes

## Other technical features



Door open alarm

Acoustic and visual

Antibacterial Gasket

Yes

Type of temperature control

Electronic

No. of compressors

1

Refrigerant gas type

R600a

Type of compressor

Inverter

Refrigerant Quantity (gr)

32 g

Foam agent

Cyclopentane

## Performance / Energy Label NEW 2019



Annual energy consumption	130 kWh/a	Airborne acoustical noise emissions	35 dB(A) re 1pW
Energy efficiency class	D	Temperature Rise Time	9 h
Airborne acoustical noise emission class	B	4 star - Freezing capacity	2.6 Kg/24h
Total net volume	270 l	Climate class	SN, N, ST, T
Sum of the volumes of the frozen compartment(s)	26 l	EI	79 %
Sum of the volumes of the chill compartment(s) and the unfrozen compartment(s)	244 l		

## Electrical Connection

Plug	(F;E) Schuko	Voltage (V)	220-240 V
Electrical connection rating	90 W	Frequency (Hz)	50/60 Hz
Current	1 A	Power supply cable length	180 cm

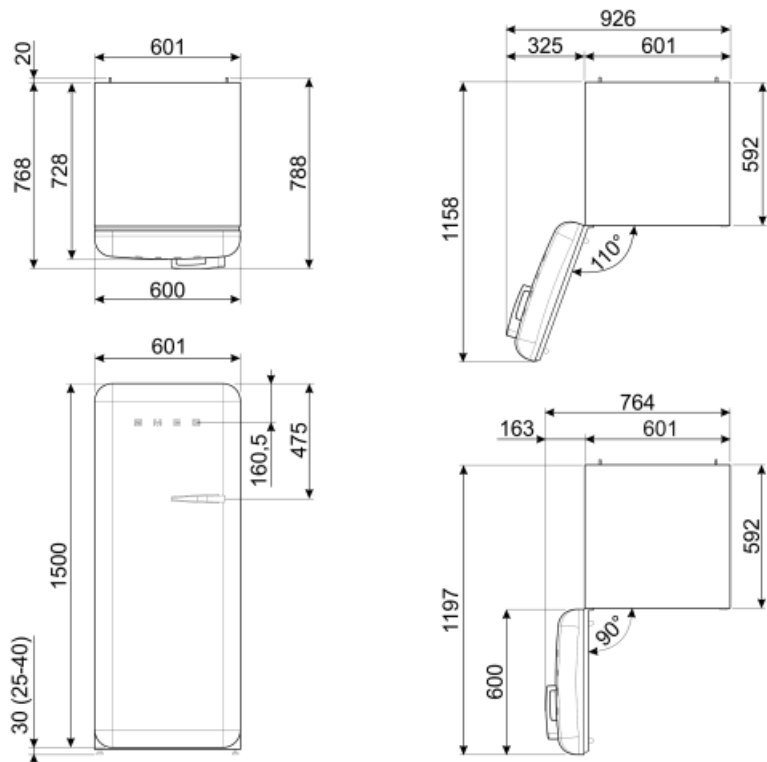

## Alternative products



**FAB28RDTP5**

**Hinge position:** Right  
Taupe



**FAB28LPK5**

**Hinge position:** Left  
Pink



**FAB28RDBLV5**

**Hinge position:** Right  
Decorated / Special



**FAB28RDRB5**

**Hinge position:** Right  
Ruby Red



**FAB28LSV5**

**Hinge position:** Left  
Silver



**FAB28RDIT5**

**Hinge position:** Right  
Decorated / Special



**FAB28LOR5**

**Hinge position:** Left  
Orange



**FAB28RCR5**

**Hinge position:** Right  
Cream



**FAB28RRD5**

**Hinge position:** Right  
Red



**FAB28RPB5**

**Hinge position:** Right  
Pastel blue



**FAB28RPG5**

**Hinge position:** Right  
Pastel green



**FAB28RYW5**

**Hinge position:** Right  
Yellow



**FAB28LRD5**

**Hinge position:** Left  
Red



**FAB28LPB5**

**Hinge position:** Left  
Pastel blue



**FAB28LPG5**

**Hinge position:** Left  
Pastel green



**FAB28RBE5**

**Hinge position:** Right  
Blue



**FAB28RDUJ5**

**Hinge position:** Right  
Decorated / Special



**FAB28RDMC5**

**Hinge position:** Right  
Decorated / Special



**FAB28LCR5**

**Hinge position:** Left  
Cream



**FAB28RDMM5**

**Hinge position:** Right  
Decorated / Special



**FAB28RWH5**

**Hinge position:** Right  
White



**FAB28LYW5**

**Hinge position:** Left  
Yellow



**FAB28RDEG5**

**Hinge position:** Right  
Emerald Green



**FAB28LDUJ5**

**Hinge position:** Left  
Decorated / Special



**FAB28RSV5**

**Hinge position:** Right  
Silver



**FAB28RDBB5**

**Hinge position:** Right  
Decorated / Special



**FAB28ROR5**

**Hinge position:** Right  
Orange



**FAB28RBL5**

**Hinge position:** Right  
Black



**FAB28RLI5**

**Hinge position:** Right  
Lime green



**FAB28RPK5**











**Hinge position:** Right  
Pink



**FAB28LWH5**

**Hinge position:** Left  
White

## Symbols glossary (TT)

	4 stars freezing compartment for better food preservation.		The automatic defrost system works by automatically defrosting at regular intervals eliminating the need to defrost altogether.
	Antibacterial treatment: antibacterial treatment to ensure better hygiene		Energy efficiency class D
	A+++: Appliances with this symbol can reduce energy consumption by a further 30% from the standard A energy rating.		Ventilated: Forced distribution of cold air in the refrigerator compartment, which allows even temperature distribution within the fridge.
	LED interior lighting: is a more energy efficient and long lasting way of illuminating the interior of the appliance.		Life Plus 0°C: The temperature in the Lifeplus compartments is kept at 0°C, which preserves fresh meat and fish longer.
	Smeg's evolution towards more intelligent and eco-friendly models has led to the choice of Inverter technology, which significantly reduces consumption.		Air plus: keeps food fresher for longer.