

# FAB28RDLB5



Product Family	Refrigerator
Installation	Free Standing
Category	One Door
Reference width	Until 60
Reference height	100 - 160
Cooling type	Fan assisted refrigerator, static freezer
Defrost	Automatic for refrigerator, manual for freezer
Hinge type	Standard
Hinge position	Right
EAN code	8017709330620



## Aesthetics

Aesthetics	50's Style	Logo colour	Chrome
Colour	Light Blue	Side material	Steel
Finishing	Matte	Side colour	Decorated / Special
Design	Rounded	Logo	Applied
Material	Heat-moulded	Door shelves profile colour	Chrome
Handle	External	Drawers profile colour	Chrome
Handle type	Fixed	Colour of glass shelf profile	Chrome
Handle colour	Chrome		

## Refrigerator compartment features



No. of adjustable shelves	2	Type of crisper/vegetable drawers cover	Glass
Number of fruit and vegetables drawers	1	Life Plus zone-0°C	Yes
Type of adjustable shelves	Glass	Internal light in fridge	Yes
Type of crisper/vegetable drawers cover	On sliding rails	Type of internal light (fridge)	LED
Crisper Cover	Yes		

## Refrigerator Inner Door

No. of bottle shelves	1
-----------------------	---

No. of door shelves with transparent cover	1	Bottle shelves with wire support	Yes
Number of adjustable door shelves	1		
Adjustable door shelves with wire support	Yes		

## Other Refrigerator features



MultiFlow	Yes	Fan	Yes
-----------	-----	-----	-----

## Freezer compartment features

Internal freezer compartment	Yes
------------------------------	-----

## Other technical features



Door open alarm	Acoustic and visual
Type of temperature control	Electronic
No. of compressors	1
Refrigerant gas type	R600a
Type of compressor	Variable Speed Compressor
Refrigerant Quantity (gr)	32 g
Foam agent	Cyclopentane

## Performance / Energy Label NEW



Annual energy consumption	130 KWh/year	Noise level	35 dB(A) re 1 pW
Energy efficiency class	D	Thaw time	9 h
Airborne acoustical noise emission class	B	4 star - Freezing capacity	2.6 Kg/24h
Total volume	270 l	Climatic class	SN, N, ST, T
Sum of the volumes of the frozen compartment(s)	26 l	EEl	79 %
Sum of the volumes of the chill compartment(s) and the unfrozen compartment(s)	244 l		

## Electrical Connection

<b>Plug</b>	(F;E) Schuko	<b>Voltage (V)</b>	220-240 V
<b>Nominal power</b>	90 W	<b>Frequency (Hz)</b>	50/60 Hz
<b>Current</b>	1 A	<b>Power supply cable length</b>	180 cm

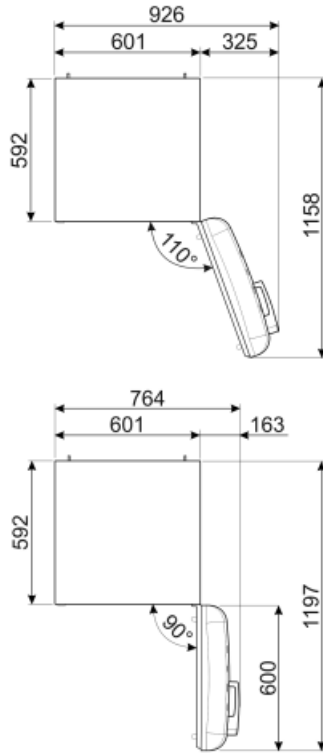
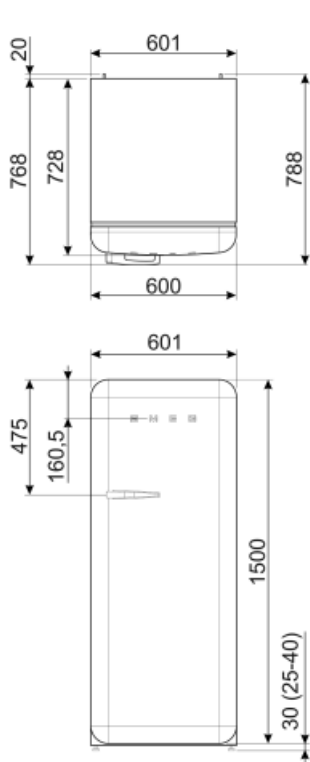

## Symbols glossary

-  4 stars freezing compartment for better food preservation.
-  The automatic defrost system works by automatically defrosting at regular intervals eliminating the need to defrost altogether.
-  LED interior lighting: is a more energy efficient and long lasting way of illuminating the interior of the appliance.
-  Inverter technology: The evolution of Smeg's driers towards more intelligent and environmentally sustainable models has led to the choice of using Inverter technology with heat pumps, which reduces significantly energy consumption.
-  Energy efficiency class D
-  A+++: Appliances with this symbol can reduce energy consumption by a further 30% from the standard A energy rating.
-  Ventilated: Forced distribution of cold air in the refrigerator compartment, which allows even temperature distribution within the fridge.
-  Life Plus 0°C: The temperature in the Lifeplus compartments is kept at 0°C, which preserves fresh meat and fish longer.
-  Air plus: keeps food fresher for longer.