

FAB28RDLB5



Product familie	Koelkast
Installatie	Vrijstaand
Categorie	Enkeldeurs koelkast
Referentie breedte	Tot 60 cm cm
Referentie hoogte	100 - 160 cm cm
Type koelen	Geventileerde koelkast, statische vriezer
Ontdooien	Automatisch ontdooien koelkast, manueel vriezer
Type scharnier	Standaard
Positie scharnier	Rechts
EAN-code	8017709330620



Design

Design	50's Style	Kleur logo	Chroom
Kleur	Light Blue	Materiaal zijwanden	Staal
Design	Bol	Kleur zijkanten	Gedecoreerd
Afwerking	Mat	Logo	Geassembleerd
Materiaal deur	Thermisch gevormd kunststof	Kleur profielen binnenzijde	Chroom
Handgreep	Extern	Kleur profielen laden	Chroom
Type handgreep	Vast	Kleur profiel glazen leggers	Chroom
Kleur handgreep	Chroom		

Uitrusting koelkast



Number of compartments	2	Afdekplaat groentenlade	Ja
Compartment types	Low temperature compartment, Fruit and vegetable compartment	Type afdekplaat groente-/fruitlade	Glas
Aantal verstelbare leggers	2	Low temperature compartment	Ja
Aantal groente-/fruitlades	1	Binnenverlichting koelkast	Ja
Shelves material	Glas	Type binnenverlichting koelkast	LED
Type afdekplaat groente-/fruitlade	Op telescopische geleiders		

Binnendeur koelkast

Aantal binnendeurcompartimenten met transparante deksel	1	Aantal flessenhouders	1
Aantal verstelbare binnendeurcompartimenten	1	Flessenhouders met metalen steunen	Ja
Binnendeurcompartimenten met metalen steunen	Ja		

Overige features koelkast



MultiFlow

Ja

Ventilator

Ja

Uitrusting vriezer

Vriesvak Ja

Overige technische eigenschappen



Alarm open deur	Akoestisch en visueel
Type temperatuurcontrole	Elektronisch
Aantal compressoren	1
Type koelgas	R600a
Type compressor	Variabele toeren
Hoeveelheid koelmiddel	32 g
Schuimmiddel	Cyclopentaan

Prestaties/Energie label - Reg. 2019



Annual energy consumption	130 kWh/jaar	Geluidsniveau	35 dB(A) re 1 pW
Energie-efficiëntieklasse	D	Conserveringsduur zonder stroom	9 h
Emissieklasse voor akoestisch luchtgeluid	B	4 star - Freezing capacity	2,6 kg/24h
Totaal netto volume	270 l	Klimaatklasse	SN, N, ST, T
Netto inhoud vriesgedeelte	26 l	EEL	79 %
Netto inhoud koelgedeeltes	244 l		

Elektrische aansluiting

Nominale aansluitwaarde	90 W	Frequentie (Hz)	50/60 Hz
Stroom (A)	1 A	Lengte stroomkabel	180 cm
Spanning (V)	220-240 V	Stekker	(F;E) Schuko

Logistieke informatie

Breedte product (mm) 601 mm
 Diepte zonder handvat en spacer 728 mm
 Maximum hoogte 1530 mm

Product breedte met maximale deuropening 926 mm
 Diepte toestel met handvat 768 mm
 Diepte toestel met deuren open 90° 1197 mm

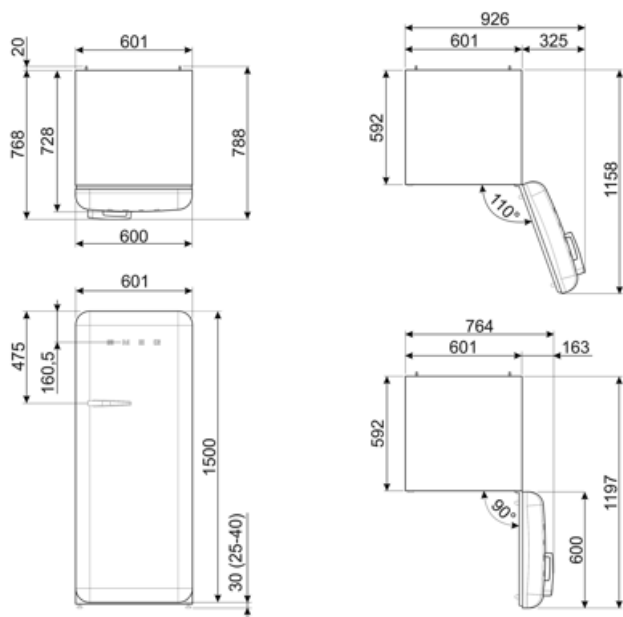

Alternative products



FAB28RDTP5

Positie scharnier: Rechts
Taupe



FAB28RDIT5

Positie scharnier: Rechts
Gedecoreerd/ Speciaal



FAB28RCR5

Positie scharnier: Rechts
Crème



FAB28RPB5

Positie scharnier: Rechts
Pastelblauw



FAB28RYW5

Positie scharnier: Rechts
Geel



FAB28RDUJ5

Positie scharnier: Rechts
Gedecoreerd/ Speciaal



FAB28RDMC5

Positie scharnier: Rechts
Gedecoreerd/ Speciaal



FAB28RDBB5

Positie scharnier: Rechts
Gedecoreerd/ Speciaal



FAB28RWH5

Positie scharnier: Rechts
Wit



FAB28RDRB5

Positie scharnier: Rechts
Ruby Red



FAB28RDPP5

Positie scharnier: Rechts
Perfectly Pale



FAB28RRD5

Positie scharnier: Rechts
Rood



FAB28RPG5

Positie scharnier: Rechts
Pastelgroen



FAB28RBE5

Positie scharnier: Rechts
Blauw



FAB28RDSA5

Positie scharnier: Rechts
Sea Salt Green



FAB28RDBLM5

Positie scharnier: Rechts
Mat zwart



FAB28ROR5

Positie scharnier: Rechts
Oranje



FAB28RDRU5

Positie scharnier: Rechts
Rust



FAB28RBL5

Positie scharnier: Rechts
Zwart



FAB28RDEG5

Positie scharnier: Rechts
Emerald green



FAB28RSV5

Positie scharnier: Rechts
Zilver



FAB28RLI5

Positie scharnier: Rechts
Limegroen



FAB28RPK5

Positie scharnier: Rechts
Roze

Symbols glossary

- | | | | |
|--|---|---|--|
|  | 4 stars freezing compartment for better food preservation. |  | The automatic defrost system works by automatically defrosting at regular intervals eliminating the need to defrost altogether. |
|  | A+++: Appliances with this symbol can reduce energy consumption by a further 30% from the standard A energy rating. |  | Geventileerd: een geforceerde verdeling van koude lucht in het koelkast compartiment, die een gelijke temperatuurverdeling verzekert in de koelkast. |
|  | LED interior lighting: is a more energy efficient and long lasting way of illuminating the interior of the appliance. |  | De evolutie van Smeg vaatwassers naar meer intelligente en milieuvriendelijke modellen heeft ertoe geleid om de inverter technologie te gebruiken, die een significante energie- en geluidsbesparing met zich meebrengt. |
|  | Multiflow Cooling System: the Multiflow ventilation system allows an even distribution of cool air around the fridge cabinet. |  | Energie-efficiëntieklasse |