

# FAB28RDPP5



Product familie	Koelkast
Installatie	Vrijstaand
Categorie	Enkeldeurs koelkast
Referentie breedte	Tot 60 cm
Referentie hoogte	100 - 160 cm
Type koelen	Geventileerde koelkast, statische vriezer
Ontdooien	Automatisch ontdooien koelkast, manueel vriezer
Type scharnier	Standaard
Positie scharnier	Rechts
EAN-code	8017709330606



## Design

Design	50's Style	Kleur logo	Chroom
Kleur	Perfectly Pale	Materiaal zijwanden	Staal
Afwerking	Mat	Kleur zijkanten	Gedecoreerd
Design	Bol	Logo	Geassembleerd
Materiaal deur	Thermisch gevormd kunststof	Kleur profielen binnenzijde	Chroom
Handgreep	Extern	Kleur profielen laden	Chroom
Type handgreep	Vast	Kleur profiel glazen leggers	Chroom
Kleur handgreep	Chroom		

## Uitrusting koelkast



Aantal verstelbare leggers	2	Type afdekplaat groente-/fruitlade	Glas
Aantal groente-/fruitlades	1	Life Plus zone 0°C	Ja
Type verstelbare leggers	Glas	Binnenverlichting koelkast	Ja
Type afdekplaat groente-/fruitlade	Op telescopische geleiders	Type binnenverlichting koelkast	LED
Afdekplaat groentenlade	Ja		

## Binnendeur koelkast

Aantal flessenhouders 1

Aantal binnendeurcompartimenten met transparante deksel	1	Flessenhouders met metalen steunen	Ja
---	---	------------------------------------	----

Aantal verstelbare binnendeurcompartimenten	1
Binnendeurcompartimenten met metalen steunen	Ja

## Overige features koelkast



MultiFlow	Ja
-----------	----

Ventilator	Ja
------------	----

## Uitrusting vriezer

Vriesvak	Ja
----------	----

## Overige technische eigenschappen



Alarm open deur	Akoestisch en visueel
-----------------	-----------------------

Anti bacteriële pakking	Ja
-------------------------	----

Type temperatuurcontrole	Elektronisch
--------------------------	--------------

Aantal compressoren	1
---------------------	---

Type koelgas	R600a
--------------	-------

Type compressor	Variabele toeren
-----------------	------------------

Hoeveelheid koelmiddel	32 g
------------------------	------

Schuimmiddel	Cyclopentaan
--------------	--------------

## Prestaties/Energie label - Reg. 2019



Annual energy consumption	130 KWh/jaar	Geluidsniveau	35 dB(A) re 1pW
---------------------------	--------------	---------------	-----------------

Energie-efficiëntieklasse	D	Conserveringsduur zonder stroom	9 h
---------------------------	---	---------------------------------	-----

Emissieklasse voor akoestisch luchtgeluid	B	4 star - Freezing capacity	2.6 Kg/24h
---	---	----------------------------	------------

Totaal netto volume	270 l	Klimaatklasse	SN, N, ST, T
---------------------	-------	---------------	--------------

Netto inhoud vriesgedeelte	26 l	EEL	79 %
----------------------------	------	-----	------

Netto inhoud koelgedeeltes	244 l
----------------------------	-------

## Elektrische aansluiting

Stekker	(F;E) Schuko	Spanning (V)	220-240 V
---------	--------------	--------------	-----------

Nominale aansluitwaarde 90 W  
Stroom (A) 1 A



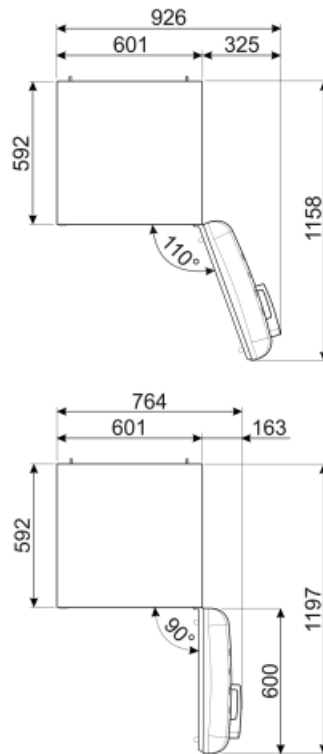
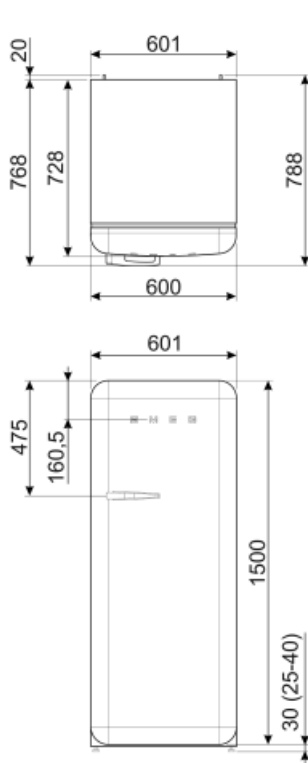







Frequentie (Hz) 50/60 Hz  
Lengte stroomkabel 180 cm



---

## Symbols glossary (TT)

---

- |  |  |   |  |
|--|--|---|--|
|  | 4 stars freezing compartment for better food preservation.   |  | A+++: Appliances with this symbol can reduce energy consumption by a further 30% from the standard A energy rating.  |
|  | The automatic defrost system works by automatically defrosting at regular intervals eliminating the need to defrost altogether.                      |  | Antibacterial treatment: antibacterial treatment to ensure better hygiene  |
|  | Geventileerd: een geforceerde verdeling van koude lucht in het koelkast compartiment, die een gelijke temperatuurverdeling verzekert in de koelkast. |  | LED interior lighting: is a more energy efficient and long lasting way of illuminating the interior of the appliance.  |
|  | Life Plus 0°C: The temperature in the Lifeplus compartments is kept at 0°C, which preserves fresh meat and fish longer.                              |  | De evolutie van Smeg vaatwassers naar meer intelligente en milieuvriendelijke modellen heeft ertoe geleid om de inverter technologie te gebruiken, die een significante energie- en geluidsbesparing met zich meebrengt. |
|  | Air plus: keeps food fresher for longer.   |  | Energie-efficiëntieklasse  |