

FAB28ROR5



Product Family	Refrigerator
Installation	Free Standing
Category	One Door
Reference width	Until 60
Reference height	100 - 160
Cooling type	Fan assisted refrigerator, static freezer
Defrost	Automatic for refrigerator, manual for freezer
Hinge type	Standard
Hinge position	Right
EAN code	8017709299262



Aesthetics

Aesthetics	50's Style	Logo colour	Chrome
Colour	Orange	Side material	Steel
Finishing	Gloss	Side colour	Orange
Design	Rounded	Logo	Applied
Material	Heat-moulded	Door shelves profile colour	Chrome
Handle	External	Drawers profile colour	Chrome
Handle type	Fixed	Colour of glass shelf profile	Chrome
Handle colour	Chrome		

Refrigerator compartment features



No. of adjustable shelves	2	Type of crisper/vegetable drawers cover	Glass
Number of fruit and vegetables drawers	1	Life Plus zone-0°C	Yes
Type of adjustable shelves	Glass	Internal light in fridge	Yes
Type of crisper/vegetable drawers cover	On sliding rails	Type of internal light (fridge)	LED
Crisper Cover	Yes		

Refrigerator Inner Door

No. of bottle shelves	1
-----------------------	---

No. of door shelves with transparent cover	1	Bottle shelves with wire support	Yes
Number of adjustable door shelves	1		
Adjustable door shelves with wire support	Yes		

Other Refrigerator features



MultiFlow	Yes	Fan	Yes
-----------	-----	-----	-----

Freezer compartment features

Internal freezer compartment	Yes
------------------------------	-----

Other technical features



Door open alarm	Acoustic and visual
Antibacterial Gasket	Yes
Type of temperature control	Electronic
No. of compressors	1
Refrigerant gas type	R600a
Type of compressor	Variable Speed Compressor
Refrigerant Quantity (gr)	32 g
Foam agent	Cyclopentane

Performance / Energy Label NEW

			
Annual energy consumption	130 KWh/year	Noise level	35 dB(A) re 1pW
Energy efficiency class	D	Thaw time	9 h
Airborne acoustical noise emission class	B	4 star - Freezing capacity	2.6 Kg/24h
Total volume	270 l	Climatic class	SN, N, ST, T
Sum of the volumes of the frozen compartment(s)	26 l	EEl	79 %
Sum of the volumes of the chill compartment(s) and the unfrozen compartment(s)	244 l		

Electrical Connection

Plug	(F;E) Schuko	Voltage (V)	220-240 V
Nominal power	90 W	Frequency (Hz)	50/60 Hz
Current	1 A	Power supply cable length	180 cm

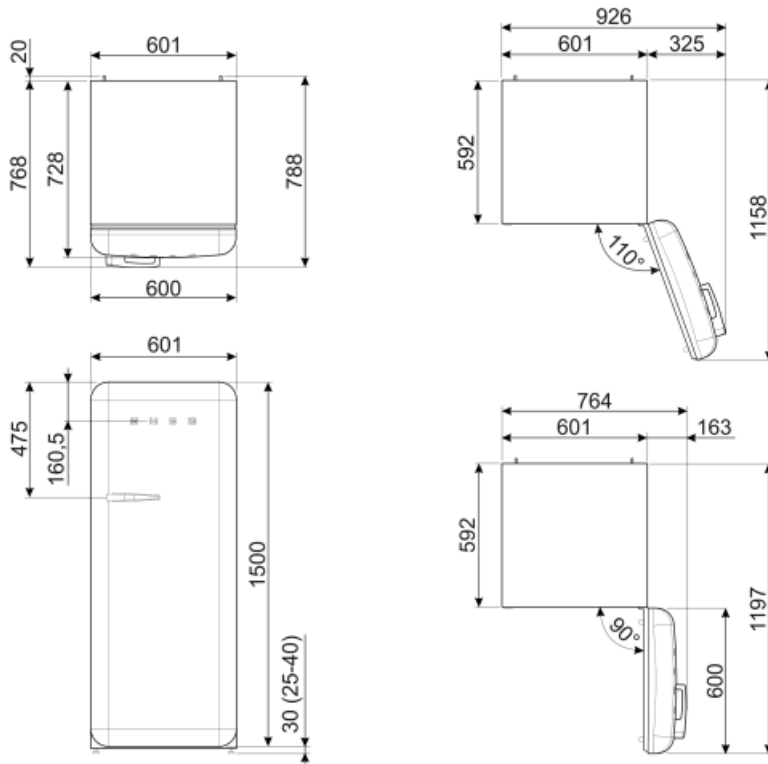

Alternative products



FAB28RDTP5

Hinge position: Right
Taupe



FAB28RDBLV5

Hinge position: Right
Decorated / Special



FAB28LBL5

Hinge position: Left
Black



FAB28RDIT5

Hinge position: Right
Decorated / Special



FAB28RCR5

Hinge position: Right
Cream



FAB28RPB5

Hinge position: Right
Pastel Blue



FAB28RYW5

Hinge position: Right
Yellow



FAB28LPB5

Hinge position: Left
Pastel Blue



FAB28LPK5

Hinge position: Left
Pink



FAB28RDRB5

Hinge position: Right
Ruby Red



FAB28LSV5

Hinge position: Left
Silver



FAB28LOR5

Hinge position: Left
Orange



FAB28RRD5

Hinge position: Right
Red



FAB28RPG5

Hinge position: Right
Pastel Green



FAB28LRD5

Hinge position: Left
Red



FAB28LPG5

Hinge position: Left
Pastel Green



FAB28RBE5

Hinge position: Right
Blue



FAB28RDMC5

Hinge position: Right
Decorated / Special



FAB28RDBB5

Hinge position: Right
Decorated / Special



FAB28RWH5

Hinge position: Right
White



FAB28LYW5

Hinge position: Left
Yellow



FAB28RDEG5

Hinge position: Right
Emerald Green



FAB28LDUJ5

Hinge position: Left
Decorated / Special



FAB28RSV5

Hinge position: Right
Silver



FAB28RDUJ5

Hinge position: Right
Decorated / Special



FAB28LCR5

Hinge position: Left
Cream



FAB28RDMM5

Hinge position: Right
Decorated / Special



FAB28RBL5

Hinge position: Right
Black



FAB28RLI5

Hinge position: Right
Lime green



FAB28RPK5











Hinge position: Right
Pink



FAB28LWH5

Hinge position: Left
White

Symbols glossary

	4 stars freezing compartment for better food preservation.		The automatic defrost system works by automatically defrosting at regular intervals eliminating the need to defrost altogether.
	Antibacterial treatment: antibacterial treatment to ensure better hygiene		Energy efficiency class D
	A+++: Appliances with this symbol can reduce energy consumption by a further 30% from the standard A energy rating.		Ventilated: Forced distribution of cold air in the refrigerator compartment, which allows even temperature distribution within the fridge.
	LED interior lighting: is a more energy efficient and long lasting way of illuminating the interior of the appliance.		Life Plus 0°C: The temperature in the Lifeplus compartments is kept at 0°C, which preserves fresh meat and fish longer.
	Inverter technology: The evolution of Smeg's driers towards more intelligent and environmentally sustainable models has led to the choice of using Inverter technology with heat pumps, which reduces significantly energy consumption.		Air plus: keeps food fresher for longer.