

# FAB28RPK5



<b>Product Family</b>	Refrigerator
<b>Installation</b>	Free Standing
<b>Category</b>	One Door
<b>Reference width</b>	Until 60
<b>Reference height</b>	100 - 160
<b>Cooling type</b>	Fan assisted refrigerator, static freezer
<b>Defrost</b>	Automatic for refrigerator, manual for freezer
<b>Hinge type</b>	Standard
<b>Hinge position</b>	Right
<b>EAN code</b>	8017709299309



## Aesthetics

<b>Aesthetics</b>	50's Style	<b>Logo colour</b>	Chrome
<b>Colour</b>	Pink	<b>Side material</b>	Steel
<b>Finishing</b>	Gloss	<b>Side colour</b>	Pink
<b>Design</b>	Rounded	<b>Logo</b>	Applied
<b>Material</b>	Heat-moulded	<b>Door shelves profile colour</b>	Chrome
<b>Handle</b>	External	<b>Drawers profile colour</b>	Chrome
<b>Handle type</b>	Fixed	<b>Colour of glass shelf profile</b>	Chrome
<b>Handle colour</b>	Chrome		

## Refrigerator compartment features



<b>No. of adjustable shelves</b>	2	<b>Type of crisper/vegetable drawers cover</b>	Glass
<b>Number of fruit and vegetables drawers</b>	1	<b>Life Plus zone-0°C</b>	Yes
<b>Type of adjustable shelves</b>	Glass	<b>Internal light in fridge</b>	Yes
<b>Type of crisper/vegetable drawers cover</b>	On sliding rails	<b>Type of internal light (fridge)</b>	LED
<b>Crisper Cover</b>	Yes		

## Refrigerator Inner Door

<b>No. of bottle shelves</b>	1
------------------------------	---

No. of door shelves with transparent cover	1	Bottle shelves with wire support	Yes
Number of adjustable door shelves	1		
Adjustable door shelves with wire support	Yes		

## Other Refrigerator features



MultiFlow	Yes	Fan	Yes
-----------	-----	-----	-----

## Freezer compartment features

Internal freezer compartment	Yes
------------------------------	-----

## Other technical features



Door open alarm	Acoustic and visual
Type of temperature control	Electronic
No. of compressors	1
Refrigerant gas type	R600a
Type of compressor	Variable Speed Compressor
Refrigerant Quantity (gr)	32 g
Foam agent	Cyclopentane

## Performance / Energy Label NEW

 Annual energy consumption	130 KWh/year	Noise level	35 dB(A) re 1 pW
Energy efficiency class	D	Thaw time	9 h
Airborne acoustical noise emission class	B	4 star - Freezing capacity	2.6 Kg/24h
Total volume	270 l	Climatic class	SN, N, ST, T
Sum of the volumes of the frozen compartment(s)	26 l	EEl	79 %
Sum of the volumes of the chill compartment(s) and the unfrozen compartment(s)	244 l		

## Electrical Connection

<b>Plug</b>	(F;E) Schuko	<b>Voltage (V)</b>	220-240 V
<b>Nominal power</b>	90 W	<b>Frequency (Hz)</b>	50/60 Hz
<b>Current</b>	1 A	<b>Power supply cable length</b>	180 cm

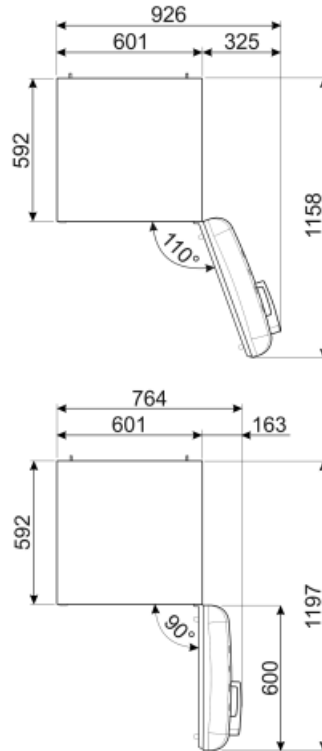
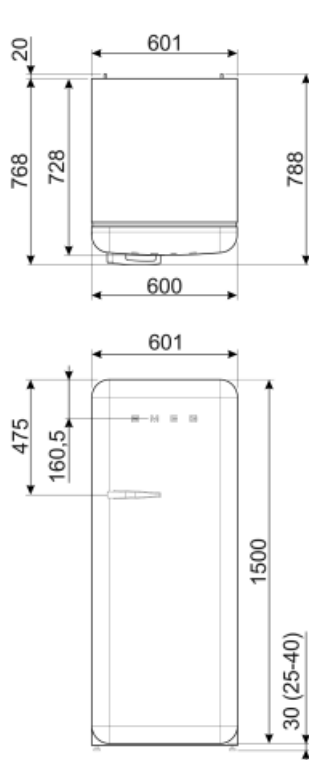

## Alternative products



**FAB28RDTP5**

**Hinge position:** Right  
Taupe



**FAB28RDBLV5**

**Hinge position:** Right  
Decorated / Special



**FAB28LBL5**

**Hinge position:** Left  
Black



**FAB28RDIT5**

**Hinge position:** Right  
Decorated / Special



**FAB28RCR5**

**Hinge position:** Right  
Cream



**FAB28RPB5**

**Hinge position:** Right  
Pastel Blue



**FAB28RYW5**

**Hinge position:** Right  
Yellow



**FAB28LPB5**

**Hinge position:** Left  
Pastel Blue



**FAB28LPK5**

**Hinge position:** Left  
Pink



**FAB28RDRB5**

**Hinge position:** Right  
Ruby Red



**FAB28LSV5**

**Hinge position:** Left  
Silver



**FAB28LOR5**

**Hinge position:** Left  
Orange



**FAB28RRD5**

**Hinge position:** Right  
Red



**FAB28RPG5**

**Hinge position:** Right  
Pastel Green



**FAB28LRD5**

**Hinge position:** Left  
Red



**FAB28LPG5**

**Hinge position:** Left  
Pastel Green



**FAB28RBE5**

**Hinge position:** Right  
Blue



**FAB28RDMC5**

**Hinge position:** Right  
Decorated / Special



**FAB28RDBB5**

**Hinge position:** Right  
Decorated / Special



**FAB28ROR5**

**Hinge position:** Right  
Orange



**FAB28RBL5**

**Hinge position:** Right  
Black



**FAB28RLI5**

**Hinge position:** Right  
Lime green



**FAB28LDUJ5**

**Hinge position:** Left  
Decorated / Special



**FAB28RSV5**

**Hinge position:** Right  
Silver



**FAB28RDUJ5**

**Hinge position:** Right  
Decorated / Special



**FAB28LCR5**

**Hinge position:** Left  
Cream



**FAB28RDMM5**

**Hinge position:** Right  
Decorated / Special



**FAB28RWH5**

**Hinge position:** Right  
White



**FAB28LYW5**

**Hinge position:** Left  
Yellow



**FAB28RDEG5**









**Hinge position:** Right  
Emerald Green



**FAB28LWH5**

**Hinge position:** Left  
White

## Symbols glossary

-  4 stars freezing compartment for better food preservation.
-  The automatic defrost system works by automatically defrosting at regular intervals eliminating the need to defrost altogether.
-  LED interior lighting: is a more energy efficient and long lasting way of illuminating the interior of the appliance.
-  Inverter technology: The evolution of Smeg's driers towards more intelligent and environmentally sustainable models has led to the choice of using Inverter technology with heat pumps, which reduces significantly energy consumption.
-  Energy efficiency class D
-  A+++: Appliances with this symbol can reduce energy consumption by a further 30% from the standard A energy rating.
-  Ventilated: Forced distribution of cold air in the refrigerator compartment, which allows even temperature distribution within the fridge.
-  Life Plus 0°C: The temperature in the Lifeplus compartments is kept at 0°C, which preserves fresh meat and fish longer.
-  Air plus: keeps food fresher for longer.