

FAB30LCR5



Product familie	Koelkast
Installatie	Vrijstaand
Categorie	Koel-vriescombinatie
Referentie breedte	Tot 60 cm
Type koelen	Geventileerde koelkast, statische vriezer
Ontdooien	Manueel ontdooien
Type scharnier	Standaard
Positie scharnier	Links
EAN-code	8017709297633



Design

Design	50's Style	Kleur logo	Chroom
Kleur	Crème	Materiaal zijwanden	Staal
Afwerking	Glanzend	Kleur zijkanten	Crème
Design	Bol	Logo	Geassembleerd
Materiaal deur	Thermisch gevormd kunststof	Kleur profielen binnenzijde	Chroom
Handgreep	Extern	Kleur profielen laden	Chroom
Type handgreep	Vast	Kleur profiel glazen leggers	Chroom
Kleur handgreep	Chroom	Beschikbare kleuren	Oranje, Pastelblauw, Wit, Blauw, Zwart, Crème, Roze, Rood, Zilver, Watergroen, Limegroen

Uitrusting koelkast



Aantal verstelbare leggers	2	Type afdekplaat groente-/fruitlade	Glas
Aantal groente-/fruitlades	1	Life Plus zone 0°C	Ja
Type verstelbare leggers	Glas	Binnenverlichting koelkast	Ja
Type afdekplaat groente-/fruitlade	Op telescopische geleiders	Type binnenverlichting koelkast	LED
Afdekplaat groentenlade	Ja		

Binnendeur koelkast

Aantal binnendeurcompartimenten met transparante deksel	1	Aantal flessenhouders	1
Aantal verstelbare binnendeurcompartimenten	2	Flessenhouders met metalen steunen	Ja
Binnendeurcompartimenten met metalen steunen	Ja		

Overige features koelkast



MultiFlow	Ja	Ventilator	Ja
-----------	----	------------	----

Uitrusting vriezer

Aantal legplanken	1	Type leggers	Draadroosters
-------------------	---	--------------	---------------

Overige technische eigenschappen



Alarm open deur	Akoestisch en visueel
Type temperatuurcontrole	Elektronisch
Aantal compressoren	1
Type koelgas	R600a
Type compressor	Variabele toeren
Hoeveelheid koelmiddel	70 g
Schuimmiddel	Cyclopentaan

Prestaties/Energie label - Reg. 2019



Annual energy consumption	168 KWh/jaar	Geluidsniveau	37 dB(A) re 1pW
Energie-efficiëntieklasse	D	Conserveringsduur zonder stroom	30 h
Emissieklasse voor akoestisch luchtgeluid	C	4 star - Freezing capacity	4 Kg/24h
Totaal netto volume	294 l	Klimaatklasse	SN, N, ST, T
Netto inhoud vriesgedeelte	72 l	EEl	80 %
Netto inhoud koelgedeeltes	222 l		

Elektrische aansluiting

Stekker (F;E) Schuko
Nominale aansluitwaarde 100 W
Stroom (A) 0.8 A

Spanning (V) 220-240 V
Frequentie (Hz) 50/60 Hz
Lengte stroomkabel 180 cm

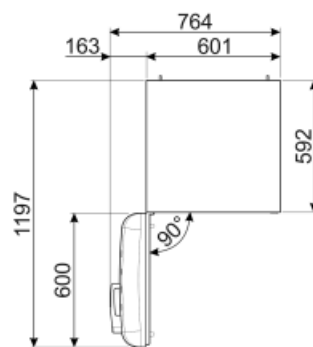
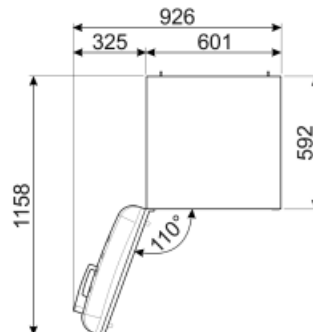
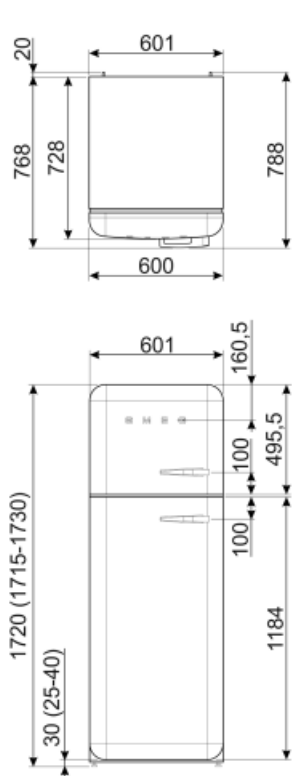

Alternative products



FAB30LPK5

Positie scharnier: Links
Roze



FAB30LSV5

Positie scharnier: Links
Zilver



FAB30LBL5

Positie scharnier: Links
Zwart



FAB30LPG5

Positie scharnier: Links
Pastelgroen



FAB30RLI5

Positie scharnier: Rechts
Limegroen



FAB30LPB5

Positie scharnier: Links
Pastelblauw



FAB30LRD5

Positie scharnier: Links
Rood



FAB30RRD5

Positie scharnier: Rechts
Rood



FAB30RPG5

Positie scharnier: Rechts
Pastelgroen



FAB30RWH5

Positie scharnier: Rechts
Wit



FAB30ROR5

Positie scharnier: Rechts
Oranje



FAB30RPK5

Positie scharnier: Rechts
Roze



FAB30RCR5

Positie scharnier: Rechts
Crème



FAB30RBL5

Positie scharnier: Rechts
Zwart



FAB30RPB5

Positie scharnier: Rechts
Pastelblauw



FAB30LOR5

Positie scharnier: Links
Oranje



FAB30RSV5

Positie scharnier: Rechts
Zilver



FAB30LWH5









Positie scharnier: Links
Wit



FAB30RBE5

Positie scharnier: Rechts
Blauw

Symbols glossary (TT)

	4 stars freezing compartment for better food preservation.		A+++: Appliances with this symbol can reduce energy consumption by a further 30% from the standard A energy rating.
	Energie-efficiëntieklasse		Geventileerd: een geforceerde verdeling van koude lucht in het koelkast compartiment, die een gelijke temperatuurverdeling verzekert in de koelkast.
	LED interior lighting: is a more energy efficient and long lasting way of illuminating the interior of the appliance.		Life Plus 0°C: The temperature in the Lifeplus compartments is kept at 0°C, which preserves fresh meat and fish longer.
	De evolutie van Smeg vaatwassers naar meer intelligente en milieuvriendelijke modellen heeft ertoe geleid om de inverter technologie te gebruiken, die een significante energie- en geluidsbesparing met zich meebrengt.		Multiflow Cooling System: the Multiflow ventilation system allows an even distribution of cool air around the fridge cabinet.