

# FAB30LCR5UK



<b>Product Family</b>	Refrigerator
<b>Installation</b>	Free standing
<b>Category</b>	Top Mount
<b>Reference width</b>	Until 60 cm
<b>Cooling type</b>	Fan assisted refrigerator, static freezer
<b>Defrost</b>	Manual
<b>Hinge type</b>	Standard
<b>Hinge position</b>	Left
<b>EAN code</b>	8017709298357



## Aesthetics

<b>Aesthetic</b>	50's Style	<b>Logo colour</b>	Chrome
<b>Colour</b>	Cream	<b>Side material</b>	Steel
<b>Design</b>	Rounded	<b>Side colour</b>	Cream
<b>Finishing</b>	Glossy	<b>Logo</b>	Applied
<b>Material</b>	Heat-moulded	<b>Door shelves profile color</b>	Chrome
<b>Handle</b>	External	<b>Drawers profile color</b>	Chrome
<b>Handle type</b>	Fixed	<b>Color of glass shelf profile</b>	Chrome
<b>Handle colour</b>	Chrome	<b>Alternative colours available</b>	Orange, Pastel blue, White, Blue, Black, Cream, Pink, Red, Silver, Pastel green, Lime green

## Refrigerator compartment features



<b>Number of compartments</b>	2	<b>Crisper Cover</b>	Yes
<b>Compartment types</b>	Low temperature compartment, Fruit and vegetable compartment	<b>Type of crisper/vegetable drawers cover</b>	Glass
<b>No. of adjustable shelves</b>	2	<b>Low temperature compartment</b>	Yes
<b>Number of fruit and vegetables drawers</b>	1	<b>Internal light in fridge</b>	Yes
<b>Type of adjustable shelves</b>	Glass	<b>Type of internal light (fridge)</b>	LED

Type of crisper/vegetable drawers cover Standard

## Refrigerator Inner Door

No. of door shelves with transparent cover	1	No. of bottle shelves	1
Number of adjustable door shelves	2	Bottle shelves with wire support	Yes
Adjustable door shelves with wire support	Yes		

## Other Refrigerator features



MultiFlow	Yes	Fan	Yes
-----------	-----	-----	-----

## Freezer compartment features

No. of shelves	1	Type of shelves	Wire
----------------	---	-----------------	------

## Other technical features



Door open alarm	Acoustic and visual
Type of temperature control	Electronic
No. of compressors	1
Refrigerant gas type	R600a
Type of compressor	Inverter
Refrigerant Quantity (g)	70 g
Foam agent	Cyclopentane

## Performance / Energy Label - Reg. 2019



Annual energy consumption	168 kWh/a	Airborne acoustical noise emissions	37 dB(A) re 1 pW
Energy efficiency class	D	Temperature Rise Time	30 h
Airborne acoustical noise emission class	C	4 star - Freezing capacity	4 kg/24h
Total net volume	294 l	Climate class	SN, N, ST, T
Sum of the volumes of the frozen compartment(s)	72 l	EEl	80 %

Sum of the volumes of the chill compartment(s) and the unfrozen compartment(s) 222 l

## Electrical Connection

Electrical connection rating	100 W	Frequency (Hz)	50/60 Hz
Current	0.8 A	Power supply cable length	180 cm
Voltage (V)	220-240 V	Plug	(G) UK e Singapore

## Logistic Information

Width	600 mm	Product depth with handle	768 mm
Depth without handle	728 mm	Product depth with doors open at 90°	1197 mm
Height	1720 mm	Spacer depth	20 mm
Product width with maximum doors opening	926 mm		

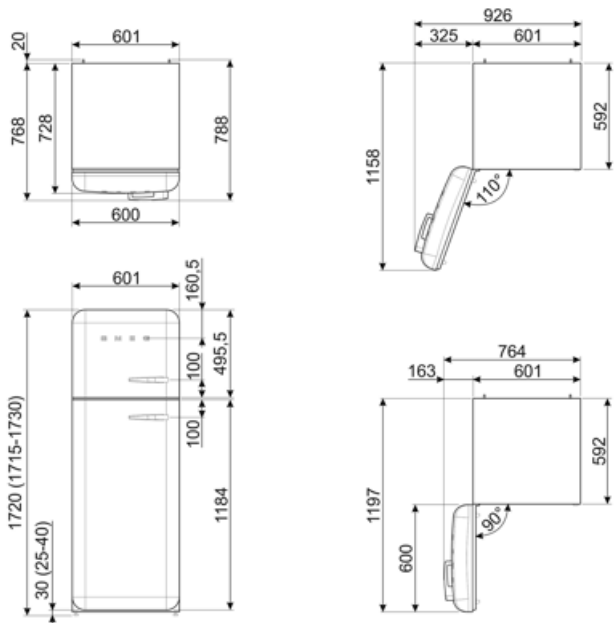

---

## Alternative products

---



**FAB30LBL5UK**

**Hinge position:** Left  
Black



**FAB30LPG5UK**

**Hinge position:** Left  
Pastel green



**FAB30LRD5UK**

**Hinge position:** Left  
Red



**FAB30LWH5UK**







**Hinge position:** Left  
White



**FAB30LPB5UK**

**Hinge position:** Left  
Pastel blue

## Symbols glossary

-  4 stars freezing compartment for better food preservation.
-  Ventilated: Forced distribution of cold air in the refrigerator compartment, which allows even temperature distribution within the fridge.
-  Smeg's evolution towards more intelligent and eco-friendly models has led to the choice of Inverter technology, which significantly reduces consumption.
-  Energy efficiency class D
-  A+++: Appliances with this symbol can reduce energy consumption by a further 30% from the standard A energy rating.
-  LED interior lighting: is a more energy efficient and long lasting way of illuminating the interior of the appliance.
-  Multiflow Cooling System: the Multiflow ventilation system allows an even distribution of cool air around the fridge cabinet.