

# FAB30LPG5UK



Product Family	Refrigerator
Installation	Free Standing
Category	Top Mount
Reference width	Until 60
Cooling type	Fan assisted refrigerator, static freezer
Defrost	Manual
Hinge type	Standard
Hinge position	Left
EAN code	8017709298432



## Aesthetics

Aesthetics	50's Style	Logo colour	Chrome
Colour	Pastel Green	Side material	Steel
Finishing	Gloss	Side colour	Pastel green
Design	Rounded	Logo	Applied
Material	Heat-moulded	Door shelves profile colour	Chrome
Handle	External	Drawers profile colour	Chrome
Handle type	Fixed	Colour of glass shelf profile	Chrome
Handle colour	Chrome	Colori disponibili	Orange, Pastel blue, White, Blue, Black, Cream, Pink, Red, Silver, Pastel green, Lime green

## Refrigerator compartment features



No. of adjustable shelves	2	Type of crisper/vegetable drawers cover	Glass
Number of fruit and vegetables drawers	1	Life Plus zone-0°C	Yes
Type of adjustable shelves	Glass	Internal light in fridge	Yes
Type of crisper/vegetable drawers cover	Standard	Type of internal light (fridge)	LED
Crisper Cover	Yes		

## Refrigerator Inner Door

No. of door shelves with transparent cover	1	No. of bottle shelves	1
Number of adjustable door shelves	2	Bottle shelves with wire support	Yes
Adjustable door shelves with wire support	Yes		

## Other Refrigerator features



MultiFlow	Yes	Fan	Yes
-----------	-----	-----	-----

## Freezer compartment features

No. of shelves	1	Type of shelves	Wire
----------------	---	-----------------	------

## Other Freezer features

Ice tray shelf	Yes
----------------	-----

## Other technical features



Door open alarm	Acoustic and visual
Type of temperature control	Electronic
No. of compressors	1
Refrigerant gas type	R600a
Type of compressor	Variable Speed Compressor
Refrigerant Quantity (gr)	70 g
Foam agent	Cyclopentane

## Performance / Energy Label



Annual energy consumption	168 KWh/year	Noise level	37 dB(A) re 1 pW
Energy efficiency class	D	Thaw time	30 h
Airborne acoustical noise emission class	C	4 star - Freezing capacity	4 Kg/24h
Total volume	294 l	Climatic class	SN, N, ST, T
		EEl	80 %

Sum of the volumes of the frozen compartment(s) 72 l

Sum of the volumes of the chill compartment(s) and the unfrozen compartment(s) 222 l

## Electrical Connection

Plug	(G) UK e Singapore	Voltage (V)	220-240 V
Nominal power	100 W	Frequency (Hz)	50/60 Hz
Current	0,8 A	Power supply cable length	180 cm

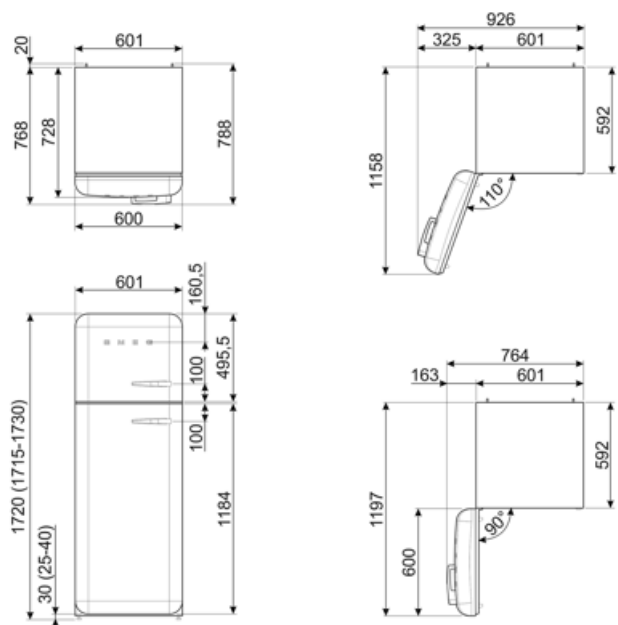

---

## Alternative products

---



**FAB30RCR5UK**

**Hinge position:** Right  
Cream



**FAB30LCR5UK**

**Hinge position:** Left  
Cream



**FAB30RWH5UK**

**Hinge position:** Right  
White



**FAB30LBL5UK**

**Hinge position:** Left  
Black



**FAB30LWH5UK**

**Hinge position:** Left  
White



**FAB30RPB5UK**

**Hinge position:** Right  
Pastel Blue



**FAB30RPG5UK**

**Hinge position:** Right  
Pastel Green



**FAB30RRD5UK**

**Hinge position:** Right  
Red



**FAB30RBL5UK**

**Hinge position:** Right  
Black



**FAB30LPB5UK**









**Hinge position:** Left  
Pastel Blue



**FAB30LRD5UK**

**Hinge position:** Left  
Red

## Symbols glossary

-  4 stars freezing compartment for better food preservation.
-  Ventilated: Forced distribution of cold air in the refrigerator compartment, which allows even temperature distribution within the fridge.
-  Life Plus 0°C: The temperature in the Lifeplus compartments is kept at 0°C, which preserves fresh meat and fish longer.
-  Air plus: keeps food fresher for longer.
-  A+++: Appliances with this symbol can reduce energy consumption by a further 30% from the standard A energy rating.
-  LED interior lighting: is a more energy efficient and long lasting way of illuminating the interior of the appliance.
-  Inverter technology: The evolution of Smeg's driers towards more intelligent and environmentally sustainable models has led to the choice of using Inverter technology with heat pumps, which reduces significantly energy consumption.
-  Energy efficiency class D

## Benefit

---

### **Plastic multiflow system**

The Multiflow system ensures even distribution of cold air inside the refrigerator

### **Fan**

The fan contributes to an even distribution of air inside the refrigerator

### **Refrigerant gas R600a**

Environmentally friendly R600a refrigerant gas contributes to rapid cooling with lower energy consumption

### **Climate class**

Climatic class SN-T makes the appliance suitable for working at room temperature between 10 °C and 43 °C (50 °F ~ 109 °F)

### **External handle**

The external handle ensures practicality and ease of use of the refrigerator

### **Life Plus 0°**

Temperature-controlled Life Plus compartment for optimal storage of specific food categories

### **Refrigerator Internal lighting**

Interior lighting for perfect visibility of shelves in the refrigerator compartment

### **Fruit and vegetable drawer**

The fruit and vegetable drawer ensures the best storage conditions for fresh food, avoiding any contamination

### **Inverter compressor**

Inverter compressor reduces noise and vibration levels for a quiet and comfortable kitchen environment

Inverter compressor technology offers significant advantages for refrigeration systems, improving both performance and efficiency. Better temperature control ensures a more stable and constant indoor environment, preserving the freshness of food. This technology also results in reduced energy consumption, as the compressor adjusts its speed according to cooling needs.