

## FAB30LRD5



Product familie	Koelkast
Installatie	Vrijstaand
Categorie	Koel-vriescombinatie
Referentie breedte	Tot 60 cm cm
Type koelen	Geventileerde koelkast, statische vriezer
Ontdooien	Manueel ontdooien
Type scharnier	Standaard
Positie scharnier	Links
EAN-code	8017709297718



## Design

Design	50's Style	Kleur logo	Chroom
Kleur	Rood	Materiaal zijwanden	Staal
Design	Bol	Kleur zijkanten	Rood
Afwerking	Glanzend	Logo	Geassembleerd
Materiaal deur	Thermisch gevormd kunststof	Kleur profielen binnenzijde	Chroom
Handgreep	Extern	Kleur profielen laden	Chroom
Type handgreep	Vast	Kleur profiel glazen leggers	Chroom
Kleur handgreep	Chroom	Beschikbare kleuren	Oranje, Pastelblauw, Wit, Blauw, Zwart, Crème, Roze, Rood, Zilver, Watergroen, Limegroen

## Uitrusting koelkast



Number of compartments	2	Afdekplaat groentenlade	Ja
Compartment types	Low temperature compartment, Fruit and vegetable compartment	Type afdekplaat groente-/fruitlade	Glas
Aantal verstelbare leggers	2	Low temperature compartment	Ja
Aantal groente-/fruitlades	1	Binnenverlichting koelkast	Ja
Shelves material	Glas	Type binnenverlichting koelkast	LED

Type afdekplaat  
groente-/fruitlade

Op telescopische geleiders

## Binnendeur koelkast

Aantal binnendeurcompartimenten met transparante deksel 1  
Aantal verstelbare binnendeurcompartimenten 2  
Binnendeurcompartimenten met metalen steunen Ja

Aantal flessenhouders 1  
Flessenhouders met metalen steunen Ja

## Overige features koelkast



Humidity Control No  
MultiFlow Ja

Ventilator Ja

## Uitrusting vriezer

Aantal legplanken 1

Type leggers Draadroosters

## Overige technische eigenschappen



Alarm open deur  
Type temperatuurcontrole  
Aantal compressoren  
Type koelgas  
Type compressor  
Hoeveelheid koelmiddel  
Schuimmiddel

Akoestisch en visueel  
Elektronisch  
1  
R600a  
Variabele toeren  
70 g  
Cyclopentaan

## Prestaties/Energie label - Reg. 2019



Annual energy consumption 168 kWh/jaar  
Energie-efficiëntieklasse D  
Emissieklasse voor akoestisch luchtgeluid C  
Totaal netto volume 294 l  
Netto inhoud vriesgedeelte 72 l  
Netto inhoud koelgedeeltes 222 l

Geluidsniveau 37 dB(A) re 1 pW  
Conserveringsduur zonder stroom 30 h  
4 star - Freezing capacity 4 kg/24h  
Klimaatklasse SN, N, ST, T  
EEI 80 %

## Elektrische aansluiting

Nominale aansluitwaarde	100 W	Frequentie (Hz)	50/60 Hz
Stroom (A)	0,8 A	Lengte stroomkabel	180 cm
Spanning (V)	220-240 V	Stekker	(F;E) Schuko

## Logistieke informatie

Breedte product (mm)	600 mm	Diepte toestel met handvat	768 mm
Diepte zonder handvat en spacer	728 mm	Diepte toestel met deuren open 90°	1197 mm
Maximum hoogte	1720 mm	Diepte uitsparing	20 mm
Product breedte met maximale deuropening	926 mm		

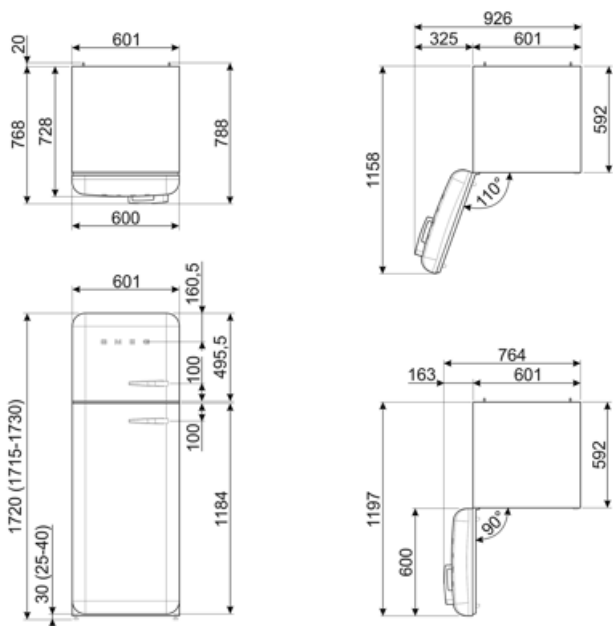

---

## Alternative products

---



**FAB30LPK5**

**Positie scharnier:** Links  
Roze



**FAB30LBL5**

**Positie scharnier:** Links  
Zwart



**FAB30LPB5**

**Positie scharnier:** Links  
Pastelblauw



**FAB30LCR5**

**Positie scharnier:** Links  
Crème



**FAB30LSV5**

**Positie scharnier:** Links  
Zilver



**FAB30LPG5**

**Positie scharnier:** Links  
Pastelgroen



**FAB30LOR5**







**Positie scharnier:** Links  
Oranje



**FAB30LWH5**

**Positie scharnier:** Links  
Wit

## Symbols glossary

-  4 stars freezing compartment for better food preservation.
-  Geventileerd: een geforceerde verdeling van koude lucht in het koelkast compartiment, die een gelijke temperatuurverdeling verzekert in de koelkast.
-  De evolutie van Smeg vaatwassers naar meer intelligente en milieuvriendelijke modellen heeft ertoe geleid om de inverter technologie te gebruiken, die een significante energie- en geluidsbesparing met zich meebrengt.
-  Energie-efficiëntieklasse
-  A+++: Appliances with this symbol can reduce energy consumption by a further 30% from the standard A energy rating.
-  LED interior lighting: is a more energy efficient and long lasting way of illuminating the interior of the appliance.
-  Multiflow Cooling System: the Multiflow ventilation system allows an even distribution of cool air around the fridge cabinet.