

# FAB32LRD5



Product familie	Koelkast
Installatie	Vrijstaand
Categorie	Koel-vriescombinatie
Referentie breedte	Tot 60 cm cm
No Frost systeem	Totaal No-Frost
Type koelen	Dubbel koelsysteem
Ontdooien	Automatisch ontdooien
Type scharnier	Standaard
Positie scharnier	Links
EAN-code	8017709298081



## Design



Design	50's Style	Materiaal zijwanden	Staal
Kleur	Rood	Kleur zijkanten	Rood
Design	Bol	Logo	Geassembleerd
Afwerking	Glanzend	Kleur profielen binnenzijde	Chroom
Materiaal deur	Thermisch gevormd kunststof	Kleur profielen laden	Chroom
Handgreep	Extern	Kleur profiel glazen leggers	Chroom
Type handgreep	Vast	Display	LED
Kleur handgreep	Chroom	Positie display	Binnen (bovenzijde)
Kleur logo	Chroom	Beschikbare kleuren	Oranje, Pastelblauw, Wit, Blauw, Zwart, Crème, Roze, Rood, Zilver, Watergroen, Limegroen

## Uitrusting koelkast

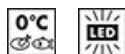

Number of compartments	2	Afdekplaat groentenlade	Ja
Compartment types	Fruit and vegetable compartment, Life Plus Compartment	Type afdekplaat groente-/fruitlade	Glas
Aantal verstelbare leggers	2	Life Plus zone 0°C	0°C
Aantal groente-/fruitlades	1	Binnenverlichting koelkast	Ja

Shelves material	Glas	Type binnenverlichting	LED
Type afdekplaat groente-/fruitlade	Op telescopische geleiders	koelkast	

## Binnendeur koelkast

Aantal binnendeurcompartimenten met transparante deksel	1	Aantal flessenhouders	1
Aantal verstelbare binnendeurcompartimenten	2	Flessenhouders met metalen steunen	Ja
Binnendeurcompartimenten met metalen steunen	Ja		

## Overige features koelkast



Humidity Control	No	Ventilator	Ja
MultiFlow	Ja		

## Uitrusting vriezer

Aantal lades	3	Type leggers	Glas
Aantal legplanken	2		

## Overige features vriezer



Snel-vriescompartment	Ja
-----------------------	----

## Overige technische eigenschappen



Display functies	Vakantiefunctie, Snel-vriesfunctie, Snel-koelfunctie, ECO, Temperatuuralarm
Snel-vriestoets	Ja
Functioneringindicator (lampje)	Ja
Indicator (lampje) temperatuuralarm	Ja
Alarm open deur	Akoestisch en visueel
Temperature Alarm	Ja
Type temperatuurcontrole	Elektronisch
Aantal compressoren	1
Type koelgas	R600a
Type compressor	Variabele toeren
Hoeveelheid koelmiddel	60 g
Schuimmiddel	Cyclopentaan

## Prestaties/Energie label - Reg. 2019

<b>Annual energy consumption</b>	204 kWh/jaar	<b>Geluidsniveau</b>	37 dB(A) re 1 pW
<b>Energie-efficiëntieklasse</b>	D	<b>Conserveringsduur zonder stroom</b>	40 h
<b>Emissieklasse voor akoestisch luchtgeluid</b>	C	<b>4 star - Freezing capacity</b>	6 kg/24h
<b>Totaal netto volume</b>	331 l	<b>Klimaatklasse</b>	SN, N, ST, T
<b>Netto inhoud vriesgedeelte</b>	97 l	<b>EI</b>	80 %
<b>Netto inhoud koelgedeeltes</b>	234 l		

## Elektrische aansluiting

<b>Nominale aansluitwaarde</b>	127 W	<b>Frequentie (Hz)</b>	50/60 Hz
<b>Stroom (A)</b>	0.8 A	<b>Lengte stroomkabel</b>	180 cm
<b>Spanning (V)</b>	220-240 V	<b>Stekker</b>	(F;E) Schuko

## Logistieke informatie

<b>Breedte product (mm)</b>	601 mm	<b>Product breedte met maximale deuropening</b>	926 mm
<b>Diepte zonder handvat en spacer</b>	728 mm	<b>Diepte toestel met handvat</b>	768 mm
<b>Maximum hoogte</b>	1968 mm	<b>Diepte toestel met deuren open 90°</b>	1197 mm

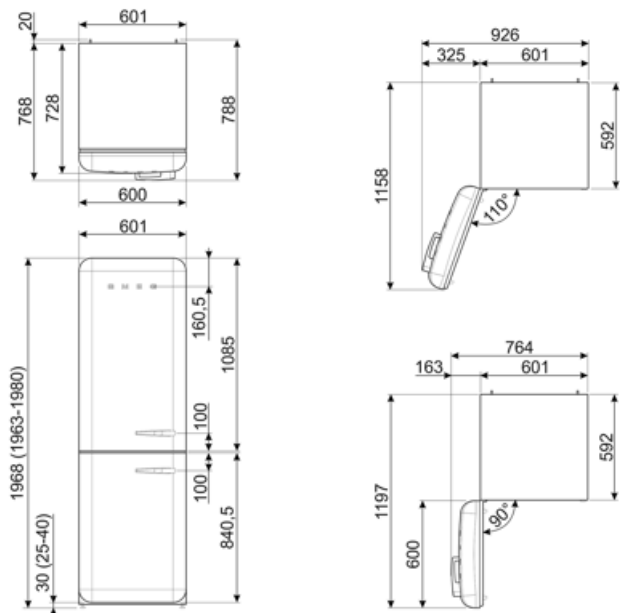

---

## Alternative products

---



**FAB32LPK5**

**Positie scharnier:** Links  
Roze



**FAB32LPG5**

**Positie scharnier:** Links  
Pastelgroen



**FAB32LBL5**

**Positie scharnier:** Links  
Zwart



**FAB32LSV5**

**Positie scharnier:** Links  
Zilver



**FAB32LWH5**

**Positie scharnier:** Links  
Wit



**FAB32LPB5**

**Positie scharnier:** Links  
Pastelblauw



**FAB32LCR5**













**Positie scharnier:** Links  
Crème



**FAB32LOR5**

**Positie scharnier:** Links  
Oranje

## Symbols glossary

	4 stars freezing compartment for better food preservation.		The automatic defrost system works by automatically defrosting at regular intervals eliminating the need to defrost altogether.
	A+++: Appliances with this symbol can reduce energy consumption by a further 30% from the standard A energy rating.		LED display: to show programmes, functions and options selected and the time to the end of the cycle.
	Economical mode: Analyzes fridge functioning during the activation and optimizes the operating cycle in order to reduce power consumption.		Geventileerd: een geforceerde verdeling van koude lucht in het koelkast compartiment, die een gelijke temperatuurverdeling verzekert in de koelkast.
	Fast freezing: The fast freezing function brings the temperature of the compartment down when activated a few hours prior to usage.		Power saving mode: The power saving mode allows you to disable the refrigerator and keep the freezer working.
	LED interior lighting: is a more energy efficient and long lasting way of illuminating the interior of the appliance.		Life Plus 0°C: The temperature in the Lifepus compartments is kept at 0°C, which preserves fresh meat and fish longer.
	De evolutie van Smeg vaatwassers naar meer intelligente en milieuvriendelijke modellen heeft ertoe geleid om de inverter technologie te gebruiken, die een significante energie- en geluidsbesparing met zich meebrengt.		Multiflow Cooling System: the Multiflow ventilation system allows an even distribution of cool air around the fridge cabinet.
	Energie-efficiëntieklasse		