

FAB32LRD5UK



Product Family	Refrigerator
Installation	Free Standing
Category	Bottom Mount
Reference width	Until 60 cm
No-Frost system	Total
Cooling type	Total No Frost - Double Cooling system
Defrost	Automatic
Hinge type	Standard
Hinge position	Left
EAN code	8017709298272



Aesthetics



Aesthetics	50's Style	Side material	Steel
Colour	Red	Side colour	Red
Design	Rounded	Logo	Applied
Finishing	Gloss	Door shelves profile colour	Chrome
Material	Heat-moulded	Drawers profile colour	Chrome
Handle	External	Colour of glass shelf profile	Chrome
Handle type	Fixed	Display	LED
Handle colour	Chrome	Display position	Interior (on the top)
Logo colour	Chrome	Colori disponibili	Orange, Pastel blue, White, Blue, Black, Cream, Pink, Red, Silver, Pastel green, Lime green

Refrigerator compartment features



Number of compartments	2	Crisper Cover	Yes
Compartment types	Fruit and vegetable compartment, Life Plus Compartment	Type of crisper/vegetable drawers cover	Glass
No. of adjustable shelves	2	Life Plus zone-0°C	0°C
		Internal light in fridge	Yes
		Type of internal light (fridge)	LED

Number of fruit and vegetables drawers	1
Shelves material	Glass
Type of crisper/vegetable drawers cover	Standard

Refrigerator Inner Door

No. of door shelves with transparent cover	1	No. of bottle shelves	1
Number of adjustable door shelves	2	Bottle shelves with wire support	Yes
Adjustable door shelves with wire support	Yes		

Other Refrigerator features



MultiFlow

Yes



Fan

Yes

Freezer compartment features

Number of drawers	3	Type of shelves	Glass
No. of compartments with flap	1		

Other Freezer features



Fast freezing compartment

Yes

Other technical features

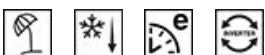

Functions display

Holiday, Fast freezing, Fast cooling, ECO, Temperature alarm

Fast freezing button

Yes

Power on lamp

Yes

Temperature alarm lamp

Yes

Door open alarm

Acoustic and visual

Temperature Alarm

Yes

Type of temperature control

Electronic

No. of compressors

1

Refrigerant gas type

R600a

Type of compressor	Inverter
Refrigerant Quantity (g)	60 g
Foam agent	Cyclopentane

Performance / Energy Label

			
Annual energy consumption	204 kWh/year	Noise level	37 dB(A) re 1 pW
Energy efficiency class	D	Thaw time	40 h
Airborne acoustical noise emission class	C	4 star - Freezing capacity	6 kg/24h
Total volume	331 l	Climatic class	SN, N, ST, T
Sum of the volumes of the frozen compartment(s)	97 l	EEl	80 %
Sum of the volumes of the chill compartment(s) and the unfrozen compartment(s)	234 l		

Electrical Connection













Nominal power	127 W	Frequency (Hz)	50/60 Hz
Current	0,8 A	Power supply cable length	180 cm
Voltage (V)	220-240 V	Plug	(G) UK e Singapore

Logistic Information

Width (mm)	601 mm	Product width with maximum doors opening	926 mm
Depth without handle	728 mm	Product depth with handle	768 mm
Product Height with feet	1968 mm	Product depth with doors open at 90°	1197 mm



Symbols glossary

	4 stars freezing compartment for better food preservation.		The automatic defrost system works by automatically defrosting at regular intervals eliminating the need to defrost altogether.
	A+++: Appliances with this symbol can reduce energy consumption by a further 30% from the standard A energy rating.		LED display: to show programmes, functions and options selected and the time to the end of the cycle.
	Economical mode: Analyzes fridge functioning during the activation and optimizes the operating cycle in order to reduce power consumption.		Ventilated: Forced distribution of cold air in the refrigerator compartment, which allows even temperature distribution within the fridge.
	Fast freezing: The fast freezing function brings the temperature of the compartment down when activated a few hours prior to usage.		Power saving mode: The power saving mode allows you to disable the refrigerator and keep the freezer working.
	LED interior lighting: is a more energy efficient and long lasting way of illuminating the interior of the appliance.		Life Plus 0°C: The temperature in the Lifeplus compartments is kept at 0°C, which preserves fresh meat and fish longer.
	Inverter technology: The evolution of Smeg's driers towards more intelligent and environmentally sustainable models has led to the choice of using Inverter technology with heat pumps, which reduces significantly energy consumption.		Air plus: keeps food fresher for longer.
	Energy efficiency class D		