

FAB32LSV5



Product familie	Koelkast
Installatie	Vrijstaand
Categorie	Koel-vriescombinatie
Referentie breedte	Tot 60 cm cm
No Frost systeem	Totaal No-Frost
Type koelen	Dubbel koelsysteem
Ontdooien	Automatisch ontdooien
Type scharnier	Standaard
Positie scharnier	Links
EAN-code	8017709298098



Design



Design	50's Style	Materiaal zijwanden	Staal
Kleur	Zilver	Kleur zijkanten	Zilver
Design	Bol	Logo	Geassembleerd
Afwerking	Glanzend	Kleur profielen binnenzijde	Chroom
Materiaal deur	Thermisch gevormd kunststof	Kleur profielen laden	Chroom
Handgreep	Extern	Kleur profiel glazen leggers	Chroom
Type handgreep	Vast	Display	LED
Kleur handgreep	Chroom	Positie display	Binnen (bovenzijde)
Kleur logo	Chroom	Beschikbare kleuren	Oranje, Pastelblauw, Wit, Blauw, Zwart, Crème, Roze, Rood, Zilver, Watergroen, Limegroen

Uitrusting koelkast



Number of compartments	2	Afdekplaat groentenlade	Ja
Compartment types	Fruit and vegetable compartment, Life Plus Compartment	Type afdekplaat groente-/fruitlade	Glas
Aantal verstelbare leggers	2	Life Plus zone 0°C	0°C
Aantal groente-/fruitlades	1	Binnenverlichting koelkast	Ja

Shelves material	Glas	Type binnenverlichting	LED
Type afdekplaat groente-/fruitlade	Op telescopische geleiders	koelkast	

Binnendeur koelkast

Aantal binnendeurcompartimenten met transparante deksel	1	Aantal flessenhouders	1
Aantal verstelbare binnendeurcompartimenten	2	Flessenhouders met metalen steunen	Ja
Binnendeurcompartimenten met metalen steunen	Ja		

Overige features koelkast



Humidity Control	No	Ventilator	Ja
MultiFlow	Ja		

Uitrusting vriezer

Aantal lades	3	Type leggers	Glas
Aantal legplanken	2		

Overige features vriezer



Snel-vriescompartment	Ja
-----------------------	----

Overige technische eigenschappen



Display functies	Vakantiefunctie, Snel-vriesfunctie, Snel-koelfunctie, ECO, Temperatuuralarm
Snel-vriestoets	Ja
Functioneringindicator (lampje)	Ja
Indicator (lampje) temperatuuralarm	Ja
Alarm open deur	Akoestisch en visueel
Temperature Alarm	Ja
Type temperatuurcontrole	Elektronisch
Aantal compressoren	1
Type koelgas	R600a
Type compressor	Variabele toeren
Hoeveelheid koelmiddel	60 g
Schuimmiddel	Cyclopentaan

Prestaties/Energie label - Reg. 2019

Annual energy consumption	204 kWh/jaar	Geluidsniveau	37 dB(A) re 1 pW
Energie-efficiëntieklasse	D	Conserveringsduur zonder stroom	40 h
Emissieklasse voor akoestisch luchtgeluid	C	4 star - Freezing capacity	6 kg/24h
Totaal netto volume	331 l	Klimaatklasse	SN, N, ST, T
Netto inhoud vriesgedeelte	97 l	EEL	80 %
Netto inhoud koelgedeeltes	234 l		

Elektrische aansluiting

Nominale aansluitwaarde	127 W	Frequentie (Hz)	50/60 Hz
Stroom (A)	0.8 A	Lengte stroomkabel	180 cm
Spanning (V)	220-240 V	Stekker	(F;E) Schuko

Logistieke informatie

Breedte product (mm)	601 mm	Product breedte met maximale deuropening	926 mm
Diepte zonder handvat en spacer	728 mm	Diepte toestel met handvat	768 mm
Maximum hoogte	1968 mm	Diepte toestel met deuren open 90°	1197 mm

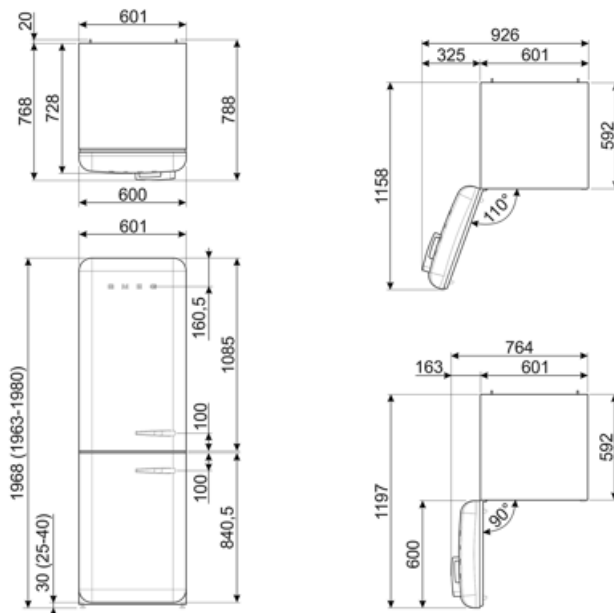

Alternative products



FAB32LRD5

Positie scharnier: Links
Rood



FAB32LPK5

Positie scharnier: Links
Roze



FAB32LWH5

Positie scharnier: Links
Wit



FAB32LPG5

Positie scharnier: Links
Pastelgroen



FAB32LPB5

Positie scharnier: Links
Pastelblauw



FAB32LBL5

Positie scharnier: Links
Zwart



FAB32LCR5













Positie scharnier: Links
Crème



FAB32LOR5

Positie scharnier: Links
Oranje

Symbols glossary

- | | |
|---|---|
|  <p>4 stars freezing compartment for better food preservation.</p> |  <p>A+++: Appliances with this symbol can reduce energy consumption by a further 30% from the standard A energy rating.</p> |
|  <p>The automatic defrost system works by automatically defrosting at regular intervals eliminating the need to defrost altogether.</p> |  <p>LED display: to show programmes, functions and options selected and the time to the end of the cycle.</p> |
|  <p>Economical mode: Analyzes fridge functioning during the activation and optimizes the operating cycle in order to reduce power consumption.</p> |  <p>Geventileerd: een geforceerde verdeling van koude lucht in het koelkast compartiment, die een gelijke temperatuurverdeling verzekert in de koelkast.</p> |
|  <p>Fast freezing: The fast freezing function brings the temperature of the compartment down when activated a few hours prior to usage.</p> |  <p>Power saving mode: The power saving mode allows you to disable the refrigerator and keep the freezer working.</p> |
|  <p>LED interior lighting: is a more energy efficient and long lasting way of illuminating the interior of the appliance.</p> |  <p>Life Plus 0°C: The temperature in the Lifeplus compartments is kept at 0°C, which preserves fresh meat and fish longer.</p> |
|  <p>De evolutie van Smeg vaatwassers naar meer intelligente en milieuvriendelijke modellen heeft ertoe geleid om de inverter technologie te gebruiken, die een significante energie- en geluidsbesparing met zich meebrengt.</p> |  <p>Multiflow Cooling System: the Multiflow ventilation system allows an even distribution of cool air around the fridge cabinet.</p> |
|  <p>Energie-efficiëntieklasse</p> | |