

FAB32RCR5



Product Family	Refrigerator
Installation	Free standing
Category	Bottom Mount
Reference width	Until 60 cm
Sistema Total No - Frost	Total
Cooling type	Total No Frost - Double Cooling system
Defrost	Automatic
Hinge type	Standard
Hinge position	Right
EAN code	8017709298135



Aesthetics



Aesthetic	50's Style	Side material	Steel
Colour	Cream	Side colour	Cream
Design	Rounded	Logo	Applied
Finishing	Glossy	Door shelves profile color	Chrome
Material	Heat-moulded	Drawers profile color	Chrome
Handle	External	Color of glass shelf profile	Chrome
Handle type	Fixed	Display	LED
Handle colour	Chrome	Display position	Interno (sul Top)
Logo colour	Chrome	Alternative colours available	Orange, Pastel blue, White, Blue, Black, Cream, Pink, Red, Silver, Pastel green, Lime green

Refrigerator compartment features



Number of compartments	2	Crisper Cover	Yes
Compartment types	Fruit and vegetable compartment, Life Plus Compartment	Type of crisper/vegetable drawers cover	Glass
No. of adjustable shelves	2	Life Plus zone-0°C	-2°C +3 °C
		Internal light in fridge	Yes
		Type of internal light (fridge)	LED

Number of fruit and vegetables drawers	1
Shelves material	Glass
Type of crisper/vegetable drawers cover	On sliding rails

Refrigerator Inner Door

No. of door shelves with transparent cover	1	No. of bottle shelves	1
Number of adjustable door shelves	2	Bottle shelves with wire support	Yes
Adjustable door shelves with wire support	Yes		

Other Refrigerator features



MultiFlow	Yes	Fan	Yes
-----------	-----	-----	-----

Freezer compartment features

Number of drawers	3	Type of shelves	Glass
No. of shelves	2		

Other Freezer features



Fast freezing compartment	Yes
---------------------------	-----

Other technical features

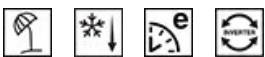

Functions display	Holiday, Fast freezing, Fast cooling, ECO, Temperature alarm
Fast freezing button	Yes
Power on lamp	Yes
Temperature alarm lamp	Yes
Door open alarm	Acoustic and visual
Temperature Alarm	Yes
Type of temperature control	Electronic
No. of compressors	1
Refrigerant gas type	R600a

Type of compressor	Inverter
Refrigerant Quantity (g)	60 g
Foam agent	Cyclopentane

Performance / Energy Label - Reg. 2019

			
Annual energy consumption	204 kWh/a	Airborne acoustical noise emissions	37 dB(A) re 1 pW
Energy efficiency class	D	Temperature Rise Time	40 h
Airborne acoustical noise emission class	C	4 star - Freezing capacity	6 kg/24h
Total net volume	331 l	Climate class	SN, N, ST, T
Sum of the volumes of the frozen compartment(s)	97 l	EEl	80 %
Sum of the volumes of the chill compartment(s) and the unfrozen compartment(s)	234 l		

Electrical Connection

Electrical connection rating	127 W	Frequency (Hz)	50/60 Hz
Current	0,8 A	Power supply cable length	180 cm
Voltage (V)	220-240 V	Plug	(F;E) Schuko

Logistic Information

Width	601 mm	Product width with maximum doors opening	926 mm
Depth without handle	728 mm	Product depth with handle	768 mm
Height	1968 mm	Product depth with doors open at 90°	1197 mm



Alternative products



FAB32RRD5

Hinge position: Right
Red



FAB32RBL5

Hinge position: Right
Black



FAB32RPK5

Hinge position: Right
Pink



FAB32RPG5

Hinge position: Right
Pastel green



FAB32RPB5

Hinge position: Right
Pastel blue



FAB32RLI5

Hinge position: Right
Lime green



FAB32RSV5

Hinge position: Right
Silver



FAB32RWH5

Hinge position: Right
White



FAB32RBE5













Hinge position: Right
Blue



FAB32ROR5

Hinge position: Right
Orange

Symbols glossary

- | | |
|--|---|
|  <p>4 stars freezing compartment for better food preservation.</p> |  <p>A+++: Appliances with this symbol can reduce energy consumption by a further 30% from the standard A energy rating.</p> |
|  <p>The automatic defrost system works by automatically defrosting at regular intervals eliminating the need to defrost altogether.</p> |  <p>LED display: to show programmes, functions and options selected and the time to the end of the cycle.</p> |
|  <p>Economical mode: Analyzes fridge functioning during the activation and optimizes the operating cycle in order to reduce power consumption.</p> |  <p>Ventilated: Forced distribution of cold air in the refrigerator compartment, which allows even temperature distribution within the fridge.</p> |
|  <p>Fast freezing: The fast freezing function brings the temperature of the compartment down when activated a few hours prior to usage.</p> |  <p>Power saving mode: The power saving mode allows you to disable the refrigerator and keep the freezer working.</p> |
|  <p>LED interior lighting: is a more energy efficient and long lasting way of illuminating the interior of the appliance.</p> |  <p>Life Plus 0°C: The temperature in the Lifeplus compartments is kept at 0°C, which preserves fresh meat and fish longer.</p> |
|  <p>Smeg's evolution towards more intelligent and eco-friendly models has led to the choice of Inverter technology, which significantly reduces consumption.</p> |  <p>Multiflow Cooling System: the Multiflow ventilation system allows an even distribution of cool air around the fridge cabinet.</p> |
|  <p>Energy efficiency class D</p> | |