

# FAB32RPB5UK



<b>Product Family</b>	Refrigerator
<b>Installation</b>	Free standing
<b>Category</b>	Bottom Mount
<b>Reference width</b>	Until 60 cm
<b>Sistema Total No - Frost</b>	Total
<b>Cooling type</b>	Total No Frost - Double Cooling system
<b>Defrost</b>	Automatic
<b>Hinge type</b>	Standard
<b>Hinge position</b>	Right
<b>EAN code</b>	8017709298289



## Aesthetics



<b>Aesthetic</b>	50's Style	<b>Side material</b>	Steel
<b>Colour</b>	Pastel blue	<b>Side colour</b>	Pastel blue
<b>Design</b>	Rounded	<b>Logo</b>	Applied
<b>Finishing</b>	Glossy	<b>Door shelves profile color</b>	Chrome
<b>Material</b>	Heat-moulded	<b>Drawers profile color</b>	Chrome
<b>Handle</b>	External	<b>Color of glass shelf profile</b>	Chrome
<b>Handle type</b>	Fixed	<b>Display</b>	LED
<b>Handle colour</b>	Chrome	<b>Display position</b>	Interno (sul Top)
<b>Logo colour</b>	Chrome	<b>Alternative colours available</b>	Orange, Pastel blue, White, Blue, Black, Cream, Pink, Red, Silver, Pastel green, Lime green

## Refrigerator compartment features



<b>Number of compartments</b>	2	<b>Crisper Cover</b>	Yes
<b>Compartment types</b>	Fruit and vegetable compartment, Life Plus Compartment	<b>Type of crisper/vegetable drawers cover</b>	Glass
<b>No. of adjustable shelves</b>	2	<b>Life Plus zone-0°C</b>	-2°C +3 °C
		<b>Internal light in fridge</b>	Yes
		<b>Type of internal light (fridge)</b>	LED

Number of fruit and vegetables drawers	1
Shelves material	Glass
Type of crisper/vegetable drawers cover	Standard

## Refrigerator Inner Door

No. of door shelves with transparent cover	1	No. of bottle shelves	1
Number of adjustable door shelves	2	Bottle shelves with wire support	Yes
Adjustable door shelves with wire support	Yes		

## Other Refrigerator features



MultiFlow

Yes



Fan

Yes

## Freezer compartment features

Number of drawers	3	Type of shelves	Glass
No. of compartments with flap	1		

## Other Freezer features



Fast freezing compartment

Yes

## Other technical features

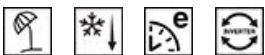

Functions display

Holiday, Fast freezing, Fast cooling, ECO, Temperature alarm

Fast freezing button

Yes

Power on lamp

Yes

Temperature alarm lamp

Yes

Door open alarm

Acoustic and visual

Temperature Alarm

Yes

Type of temperature control

Electronic

No. of compressors

1

Refrigerant gas type

R600a

Type of compressor	Inverter
Refrigerant Quantity (g)	60 g
Foam agent	Cyclopentane

## Performance / Energy Label - Reg. 2019

			
Annual energy consumption	204 kWh/a	Airborne acoustical noise emissions	37 dB(A) re 1 pW
Energy efficiency class	D	Temperature Rise Time	40 h
Airborne acoustical noise emission class	C	4 star - Freezing capacity	6 kg/24h
Total net volume	331 l	Climate class	SN, N, ST, T
Sum of the volumes of the frozen compartment(s)	97 l	EEl	80 %
Sum of the volumes of the chill compartment(s) and the unfrozen compartment(s)	234 l		

## Electrical Connection













Electrical connection rating	127 W	Frequency (Hz)	50/60 Hz
Current	0,8 A	Power supply cable length	180 cm
Voltage (V)	220-240 V	Plug	(G) UK e Singapore

## Logistic Information

Width	601 mm	Product width with maximum doors opening	926 mm
Depth without handle	728 mm	Product depth with handle	768 mm
Height	1968 mm	Product depth with doors open at 90°	1197 mm



## Symbols glossary

- |  |  |  |  |
|--|--|--|--|
|    | 4 stars freezing compartment for better food preservation.   |   | The automatic defrost system works by automatically defrosting at regular intervals eliminating the need to defrost altogether.            |
|    | A+++: Appliances with this symbol can reduce energy consumption by a further 30% from the standard A energy rating.                                      |   | LED display: to show programmes, functions and options selected and the time to the end of the cycle.                                      |
|    | Economical mode: Analyzes fridge functioning during the activation and optimizes the operating cycle in order to reduce power consumption.               |   | Ventilated: Forced distribution of cold air in the refrigerator compartment, which allows even temperature distribution within the fridge. |
|    | Fast freezing: The fast freezing function brings the temperature of the compartment down when activated a few hours prior to usage.                      |   | Power saving mode: The power saving mode allows you to disable the refrigerator and keep the freezer working.                              |
|    | LED interior lighting: is a more energy efficient and long lasting way of illuminating the interior of the appliance.                                    |   | Life Plus 0°C: The temperature in the Lifeplus compartments is kept at 0°C, which preserves fresh meat and fish longer.                    |
|   | Smeg's evolution towards more intelligent and eco-friendly models has led to the choice of Inverter technology, which significantly reduces consumption. |  | Multiflow Cooling System: the Multiflow ventilation system allows an even distribution of cool air around the fridge cabinet.              |
|  | Energy efficiency class D  |  |  |