

# FAB32RRD3UK



Product Family	Refrigerator
Installation	Free standing
Category	Bottom Mount
Sistema Total No - Frost	Total
Cooling type	Total No Frost - Double Cooling system
Defrost	Automatic
Hinge type	Standard
Hinge position	Right
EAN code	8017709262532



## Aesthetics

Aesthetic	50's Style	Side material	Steel
Colour	Red	Side colour	Red
Design	Rounded	Logo	Applied
Finishing	Glossy	Door shelves profile color	Chrome
Material	Heat-moulded	Drawers profile color	Chrome
Handle	External	Color of glass shelf profile	Chrome
Handle type	Fixed	Display	7 segments
Handle colour	Chrome	Display position	
Logo colour	Chrome	Alternative colours available	Pastel blue, White, Black, Cream, Pink, Pastel green

## Refrigerator compartment features



No. of adjustable shelves	2	Type of crisper/vegetable drawers cover	Glass
Number of fruit and vegetables drawers	1	Life Plus zone-0°C	-2°C +3 °C
Shelves material	Glass	Internal light in fridge	Yes
Type of crisper/vegetable drawers cover	Standard	Type of internal light (fridge)	LED
Crisper Cover	Yes		

## Refrigerator Inner Door

<b>No. of door shelves with transparent cover</b>	1	<b>No. of bottle shelves</b>	1
<b>Number of adjustable door shelves</b>	2	<b>Bottle shelves with wire support</b>	Yes
<b>Adjustable door shelves with wire support</b>	Yes		

## Other Refrigerator features



<b>Accessories</b>	<b>Egg tray</b>	<b>Fan</b>	<b>Yes</b>
MultiFlow	Yes		

## Freezer compartment features

<b>Number of drawers</b>	3	<b>Type of shelves</b>	Plastic
<b>No. of compartments with flap</b>	1		

## Other Freezer features



<b>Accessories</b>	<b>1 ice box</b>	<b>Fast freezing compartment</b>	<b>Yes</b>
--------------------	------------------	----------------------------------	------------

## Other technical features

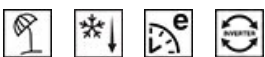

<b>Functions display</b>	Holiday, Fast freezing, Fast cooling, ECO, Temperature alarm
<b>Fast freezing button</b>	Yes
<b>Water network connection</b>	
<b>Power on lamp</b>	Yes
<b>Temperature alarm lamp</b>	Yes
<b>Door open alarm</b>	Acoustic and visual
<b>Temperature Alarm</b>	Yes
<b>Type of temperature control</b>	Electronic
<b>No. of compressors</b>	1
<b>Refrigerant gas type</b>	R600a
<b>Type of compressor</b>	Inverter
<b>Refrigerant Quantity (g)</b>	60 g
<b>Foam agent</b>	Cyclopentane

## Performance / Energy Label - Reg. 2019

<b>Climate class</b>	SN, N, ST, T
----------------------	--------------

Airborne acoustical noise emissions 37 dB(A) re 1 pW

## Electrical Connection







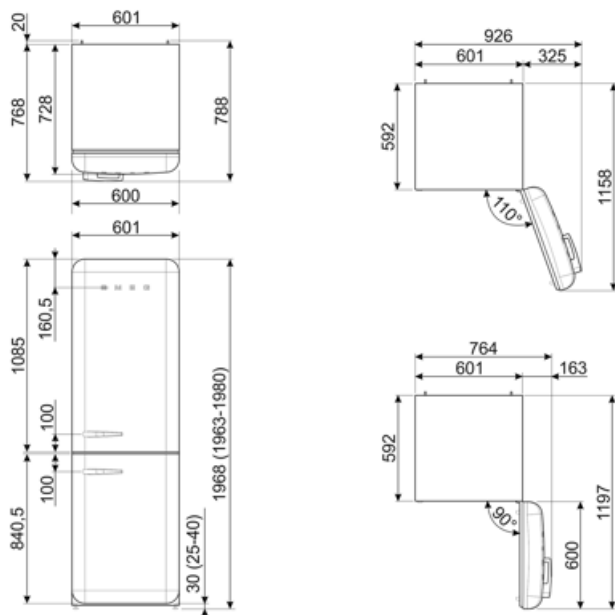



Electrical connection rating	127 W	Frequency (Hz)	50/60 Hz
Current	0,8 A	Power supply cable length	200 cm
Voltage (V)	220-240 V	Plug	(G) UK e Singapore

## Logistic Information

Width	601 mm	Product width with maximum doors opening	926 mm
Depth without handle	728 mm	Product depth with handle	768 mm
Height	1955 mm	Product depth with doors open at 90°	1197 mm



## Symbols glossary

-  4 stars freezing compartment for better food preservation.
-  The automatic defrost system works by automatically defrosting at regular intervals eliminating the need to defrost altogether.
-  Ventilated: Forced distribution of cold air in the refrigerator compartment, which allows even temperature distribution within the fridge.
-  Power saving mode: The power saving mode allows you to disable the refrigerator and keep the freezer working.
-  Life Plus 0°C: The temperature in the Lifeplus compartments is kept at 0°C, which preserves fresh meat and fish longer.
-  Multiflow Cooling System: the Multiflow ventilation system allows an even distribution of cool air around the fridge cabinet.
-  A+++: Appliances with this symbol can reduce energy consumption by a further 30% from the standard A energy rating.
-  Economical mode: Analyzes fridge functioning during the activation and optimizes the operating cycle in order to reduce power consumption.
-  Fast freezing: The fast freezing function brings the temperature of the compartment down when activated a few hours prior to usage.
-  LED interior lighting: is a more energy efficient and long lasting way of illuminating the interior of the appliance.
-  Smeg's evolution towards more intelligent and eco-friendly models has led to the choice of Inverter technology, which significantly reduces consumption.