

# FAB32RWH5



Product familie	Koelkast
Installatie	Vrijstaand
Categorie	Koel-vriescombinatie
Referentie breedte	Tot 60 cm cm
No Frost systeem	Totaal No-Frost
Type koelen	Dubbel koelsysteem
Ontdooien	Automatisch ontdooien
Type scharnier	Standaard
Positie scharnier	Rechts
EAN-code	8017709298210



## Design



Design	50's Style	Materiaal zijwanden	Staal
Kleur	Wit	Kleur zijkanten	Wit
Design	Bol	Logo	Geassembleerd
Afwerking	Glanzend	Kleur profielen binnenzijde	Chroom
Materiaal deur	Thermisch gevormd kunststof	Kleur profielen laden	Chroom
Handgreep	Extern	Kleur profiel glazen leggers	Chroom
Type handgreep	Vast	Display	LED
Kleur handgreep	Chroom	Positie display	Binnen (bovenzijde)
Kleur logo	Chroom	Beschikbare kleuren	Oranje, Pastelblauw, Wit, Blauw, Zwart, Crème, Roze, Rood, Zilver, Watergroen, Limegroen

## Uitrusting koelkast

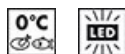

Number of compartments	2	Afdekplaat groentenlade	Ja
Compartment types	Fruit and vegetable compartment, Life Plus Compartment	Type afdekplaat groente-/fruitlade	Glas
Aantal verstelbare leggers	2	Life Plus zone 0°C	0°C
Aantal groente-/fruitlades	1	Binnenverlichting koelkast	Ja

Type verstelbare leggers	Glas	Type binnenverlichting koelkast	LED
Type afdekplaat groente-/fruitlade	Op telescopische geleiders		

## Binnendeur koelkast

Aantal binnendeurcompartimenten met transparante deksel	1	Aantal flessenhouders	1
Aantal verstelbare binnendeurcompartimenten	2	Flessenhouders met metalen steunen	Ja
Binnendeurcompartimenten met metalen steunen	Ja		

## Overige features koelkast

			
MultiFlow	Ja	Ventilator	Ja

## Uitrusting vriezer

Aantal lades	3	Type leggers	Glas
Aantal legplanken	2		

## Overige features vriezer

	
Snel-vriescompartment	Ja

## Overige technische eigenschappen

				
Display functies	Snel-vriestoets	Functioneringindicator (lampje)	Indicator (lampje) temperatuuralarm	Vakantiefunctie, Snel-vriesfunctie, Snel-koelfunctie, ECO, Temperatuuralarm
		Alarm open deur	Temperature Alarm	Ja
		Type temperatuurcontrole	Aantal compressoren	Ja
		Aantal koelgas	Type compressor	Akoestisch en visueel
		Hoeveelheid koelmiddel	Schuimmiddel	Ja
				Elektronisch
				1
				R600a
				Variabele toeren
				60 g
				Cyclopentaan

## Prestaties/Energie label - Reg. 2019

			
Annual energy consumption	204 kWh/jaar	Geluidsniveau	37 dB(A) re 1 pW
Energie-efficiëntieklasse	D	Conserveringsduur zonder stroom	40 h
Emissieklasse voor akoestisch luchtgeluid	C	4 star - Freezing capacity	6 kg/24h
Totaal netto volume	331 l	Klimaatklasse	SN, N, ST, T
Netto inhoud vriesgedeelte	97 l	EI	80 %
Netto inhoud koelgedeeltes	234 l		

## Elektrische aansluiting

Nominale aansluitwaarde	127 W	Frequentie (Hz)	50/60 Hz
Stroom (A)	0,8 A	Lengte stroomkabel	180 cm
Spanning (V)	220-240 V	Stekker	(F;E) Schuko

## Logistieke informatie

Breedte product (mm)	601 mm	Product breedte met maximale deuropening	926 mm
Diepte zonder handvat en spacer	728 mm	Diepte toestel met handvat	768 mm
Maximum hoogte	1968 mm	Diepte toestel met deuren open 90°	1197 mm

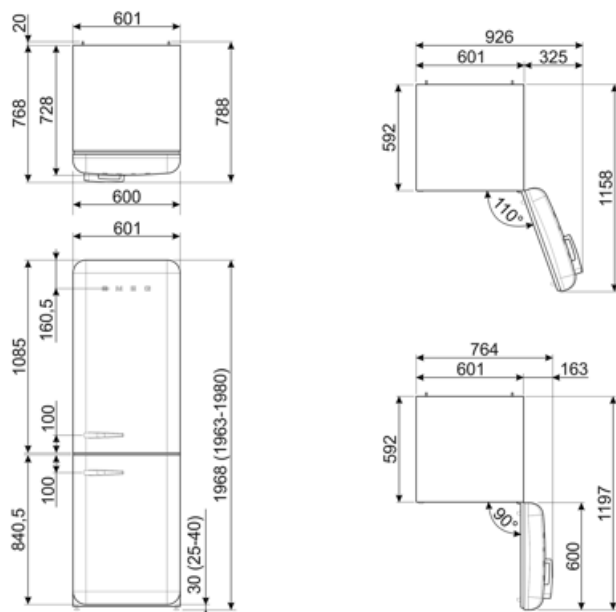

---

## Alternative products

---



**FAB32RRD5**

**Positie scharnier:** Rechts  
Rood



**FAB32RBL5**

**Positie scharnier:** Rechts  
Zwart



**FAB32RPK5**

**Positie scharnier:** Rechts  
Roze



**FAB32RPG5**

**Positie scharnier:** Rechts  
Pastelgroen



**FAB32RPB5**

**Positie scharnier:** Rechts  
Pastelblauw



**FAB32RLI5**

**Positie scharnier:** Rechts  
Limegroen



**FAB32RSV5**

**Positie scharnier:** Rechts  
Zilver



**FAB32RCR5**

**Positie scharnier:** Rechts  
Crème



**FAB32RBE5**













**Positie scharnier:** Rechts  
Blauw



**FAB32ROR5**

**Positie scharnier:** Rechts  
Oranje

## Symbols glossary

	4 stars freezing compartment for better food preservation.		The automatic defrost system works by automatically defrosting at regular intervals eliminating the need to defrost altogether.
	A+++: Appliances with this symbol can reduce energy consumption by a further 30% from the standard A energy rating.		Energie-efficiëntieklasse
	LED display: to show programmes, functions and options selected and the time to the end of the cycle.		Economical mode: Analyzes fridge functioning during the activation and optimizes the operating cycle in order to reduce power consumption.
	Geventileerd: een geforceerde verdeling van koude lucht in het koelkast compartiment, die een gelijke temperatuurverdeling verzekert in de koelkast.		Fast freezing: The fast freezing function brings the temperature of the compartment down when activated a few hours prior to usage.
	Power saving mode: The power saving mode allows you to disable the refrigerator and keep the freezer working.		LED interior lighting: is a more energy efficient and long lasting way of illuminating the interior of the appliance.
	Life Plus 0°C: The temperature in the Lifeplus compartments is kept at 0°C, which preserves fresh meat and fish longer.		De evolutie van Smeg vaatwassers naar meer intelligente en milieuvriendelijke modellen heeft ertoe geleid om de inverter technologie te gebruiken, die een significante energie- en geluidsbesparing met zich meebrengt.
	Multiflow Cooling System: the Multiflow ventilation system allows an even distribution of cool air around the fridge cabinet.		