

FAB32ULPK3

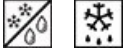

Product family	Refrigerator
Installation	Free-standing
Category	Bottom mount
Reference width	Until 60
No-frost system	Total
Cooling type	No Frost
Defrost	Automatic
Hinge position	Left
EAN code	8017709272050



Aesthetic

Aesthetics	Retro-style	Logo	Applied
Color	Pink	Door shelf profile color	Chromed
Finishing	Glossy	Drawers profile color	Chromed
Handle color	Chromed	Glass shelf profile color	Chromed
Side material	Steel	Display	7 segment
Side color	Pink		

Refrigerator compartment features



No. of adjustable shelves	3	Type of crisper cover	Glass
Number of fruit and vegetables drawers	1	LifePlus zone - 32°F	Yes
Type of adjustable shelves	Glass	Refrigerator lighting	Yes
Crisper drawer type	Standard	Refrigerator lighting	LED
Crisper cover	Yes		

Refrigerator Inner Door

No. of door shelves with transparent cover	1	No. of bottle shelves	1
Number of adjustable door shelves	2	Door bin with wire support	Yes

Adjustable door bins with wire support Yes

Other Refrigerator features



Accessories
MultiFlow

Egg tray
Yes

Fan

Yes

Freezer features

Number of drawers 2
No. of compartments with flap 1

Shelf type Plastic

Other Freezer features



Accessories

1 x ice box

Fast-freezing compartment

Yes

Other technical features



Display functions

Holiday, Fast-freezing, Fast-cooling, ECO, Temperature alarm

Fast-freezing button

Yes

Power-on light

Yes

Temperature alarm

Yes

Door open alarm

Acoustic and visual

Temperature Alarm

Yes

Temperature setting type

Electronic

No. of compressors

1

Refrigerant gas type

R600a

Compressor type

Inverter

Refrigerant quantity

2.1 oz

Foam agent

Cyclopentane

Performance / Energy Label NEW

Noise level 37 dB(A) re 1 pW

Freezer capacity

3.99 cu. ft.

Electrical Connection

Plug (A) USA & Mexico

Voltage (V)







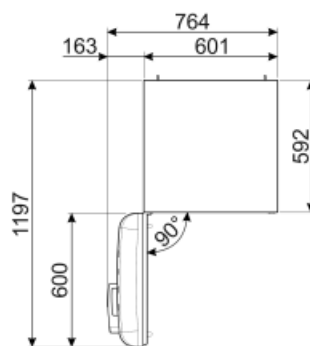
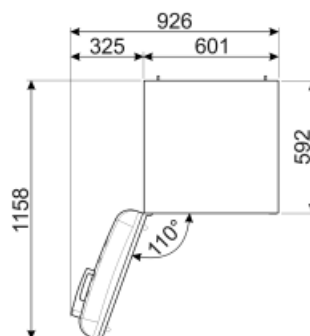
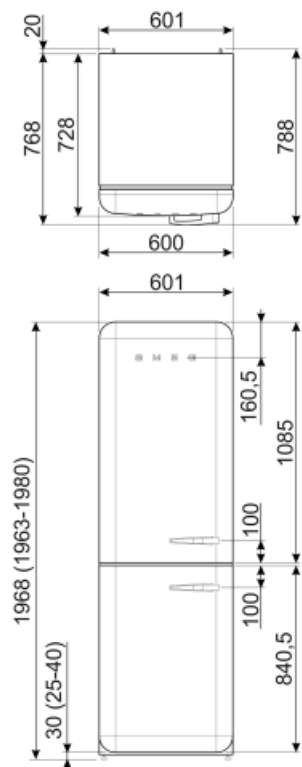



115 V

Electrical connection rating 127 W
Current 1.2 A

Frequency (Hz) 50/60 Hz
Power cord length 70 7/8 "



Symbols glossary (TT)

	The automatic defrost system works by automatically defrosting at regular intervals eliminating the need to defrost altogether.		Economical mode: Analyzes fridge functioning during the activation and optimizes the operating cycle in order to reduce power consumption.
	Ventilated: Forced distribution of cold air in the refrigerator compartment, which allows even temperature distribution within the fridge.		Fast freezing: The fast freezing function brings the temperature of the compartment down when activated a few hours prior to usage.
	Power saving mode: The power saving mode allows you to disable the refrigerator and keep the freezer working.		LED interior lighting: is a more energy efficient and long lasting way of illuminating the interior of the appliance.
	Life Plus 0°C: The temperature in the Lifeplus compartments is kept at 0°C, which preserves fresh meat and fish longer.		Inverter technology: The evolution of Smeg's driers towards more intelligent and environmentally sustainable models has led to the choice of using Inverter technology with heat pumps, which reduces significantly energy consumption.
	Air plus: keeps food fresher for longer.		No Frost: The No Frost and Frost free systems prevent ice from forming so that no defrosting is required.