

FAB32URPB3



Product Family	Refrigerator
Installation	Free standing
Category	Bottom Mount
Cooling type	No Frost
Defrost	Automatic
Hinge position	Right
EAN code	8017709272029



Aesthetics

Aesthetic	50's Style	Logo	Applied
Colour	Pastel blue	Door shelves profile color	Chrome
Finishing	Glossy	Drawers profile color	Chrome
Handle colour	Chrome	Color of glass shelf profile	Chrome
Side material	Steel	Display	7 segments
Side colour	Pastel blue	Display position	

Refrigerator compartment features



Number of compartments	2	Crisper Cover	Yes
No. of adjustable shelves	3	Type of crisper/vegetable drawers cover	Glass
Number of fruit and vegetables drawers	1	Life Plus zone-0°C	Yes, with electronic control
Shelves material	Glass	Internal light in fridge	Yes
Type of crisper/vegetable drawers cover	Standard	Type of internal light (fridge)	LED

Refrigerator Inner Door

No. of door shelves with transparent cover	1	No. of bottle shelves	1
--	---	-----------------------	---

Number of adjustable door shelves	2	Bottle shelves with wire support	Yes
Adjustable door shelves with wire support	Yes		

Other Refrigerator features



Accessories MultiFlow	Egg tray Yes	Fan	Yes
-----------------------	--------------	-----	-----

Freezer compartment features

Number of drawers	2	Type of shelves	Plastic
No. of compartments with flap	1		

Other Freezer features



Accessories	1 ice box	Fast freezing compartment	Yes
-------------	-----------	---------------------------	-----

Other technical features



Functions display	Holiday, Fast freezing, Fast cooling, ECO, Temperature alarm
Fast freezing button	Yes
Water network connection	Yes
Power on lamp	Yes
Temperature alarm lamp	Yes
Door open alarm	Acoustic and visual
Temperature Alarm	Yes
Type of temperature control	Electronic
No. of compressors	1
Refrigerant gas type	R600a
Type of compressor	Inverter
No. of evaporators	2
Refrigerant Quantity (gr)	2.1 oz
Foam agent	Cyclopentane

Performance / Energy Label - Reg. 2019

Airborne acoustical noise emissions	37 dB(A) re 1 pW	Gross volume frozen food compartment	4.0 cu. ft.
-------------------------------------	------------------	--------------------------------------	-------------

Electrical Connection

Electrical connection rating	127 W	Frequency (Hz)	50/60 Hz
Current	1.2 A	Power supply cable length	70 7/8 "
Voltage (V)	115 V	Plug	(B) NEMA 5-15P

Logistic Information

Width	23 11/16 "	Product width with maximum doors opening	36 7/16 "
Depth without handle	28 11/16 "	Product depth with handle	30 1/4 "
Height	77 1/2 "	Product depth with doors open at 90°	47 1/8 "

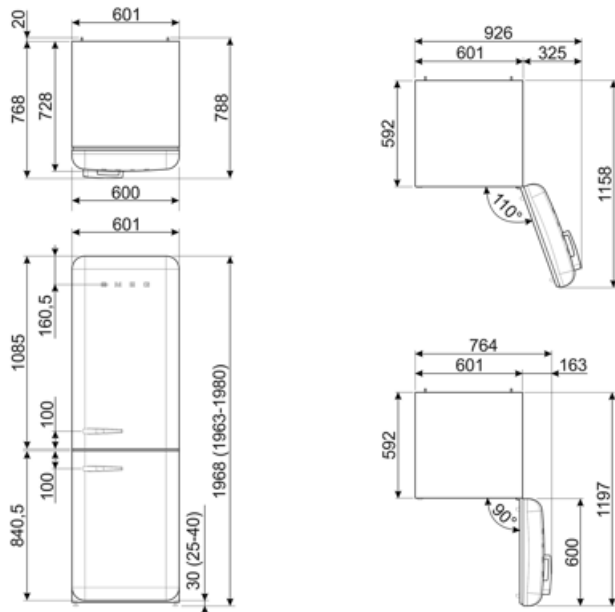

Alternative products



FAB32URRD3

Hinge position: Right
Red



FAB32UROR3

Hinge position: Right
Orange



FAB32URPK3

Hinge position: Right
Pink



FAB32URBL3

Hinge position: Right
Black



FAB32URPG3

Hinge position: Right
Pastel green



FAB32URCR3













Hinge position: Right
Cream



FAB32URWH3

Hinge position: Right
White

Symbols glossary

	4 stars freezing compartment for better food preservation.		The automatic defrost system works by automatically defrosting at regular intervals eliminating the need to defrost altogether.
	A+++: Appliances with this symbol can reduce energy consumption by a further 30% from the standard A energy rating.		Economical mode: Analyzes fridge functioning during the activation and optimizes the operating cycle in order to reduce power consumption.
	Ventilated: Forced distribution of cold air in the refrigerator compartment, which allows even temperature distribution within the fridge.		Fast freezing: The fast freezing function brings the temperature of the compartment down when activated a few hours prior to usage.
	Power saving mode: The power saving mode allows you to disable the refrigerator and keep the freezer working.		LED interior lighting: is a more energy efficient and long lasting way of illuminating the interior of the appliance.
	Life Plus 0°C: The temperature in the Lifeplus compartments is kept at 0°C, which preserves fresh meat and fish longer.		Smeg's evolution towards more intelligent and eco-friendly models has led to the choice of Inverter technology, which significantly reduces consumption.
	Air plus: keeps food fresher for longer.		No Frost: The No Frost and Frost free systems prevent ice from forming so that no defrosting is required.