

FAB38LBL5

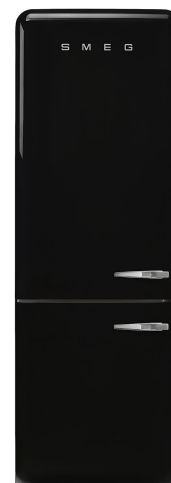

Product familie	Koelkast
Installatie	Vrijstaand
Categorie	Koel-vriescombinatie
Reference width	60 - 70
Reference height	Higher than 200
No Frost systeem	Totaal No-Frost
Type koelen	Dubbel koelsysteem
Ontdooien	Automatisch ontdooien
Type scharnier	Standaard
Positie scharnier	Links
EAN-code	8017709297855



Design



Design	50's Style	Materiaal zijwanden	Staal
Kleur	Zwart	Kleur zijkanten	Zwart
Afwerking	Glanzend	Logo	Geassembleerd
Design	Bol	Kleur profielen binnenzijde	Zilver
Materiaal deur	Thermisch gevormd kunststof	Kleur profielen laden	Zilver
Handgreep	Extern	Kleur profiel glazen leggers	Zilver
Type handgreep	Vast	Display	LED
Kleur handgreep	Chroom	Positie display	Interno (cella frigo)
Kleur logo	Chroom		

Uitrusting koelkast



Aantal verstelbare leggers	3	Type afdekplaat groente-/fruitlade	Glas
Aantal groente-/fruitlades	1	Life Plus zone 0°C	Ja
Type verstelbare leggers	Glas	Binnenverlichting koelkast	Ja
Type afdekplaat groente-/fruitlade	Op telescopische geleiders	Type binnenverlichting koelkast	LED
Afdekplaat groentenlade	Ja		

Binnendeur koelkast

Aantal verstelbare
binnendeurcompartimenten 3

Aantal flessenhouders 1

Overige features koelkast



MultiFlow Ventilator Ja
Ja

Active Ion technology Ja

Uitrusting vriezer

Aantal lades 2
Aantal legplanken 2

Aantal compartimenten met klep 1
Type leggers Glas

Overige features vriezer



Ijsmaker (manueel) Ice maker Ja
Manueel ontdooien

Snel-vriescompartiment Ja

Overige technische eigenschappen



Display functies
Snel-vriestoets
Indicator (lampje) temperatuuralarm
Alarm open deur
Temperature Alarm
Type temperatuurcontrole
Aantal compressoren
Type koelgas
Type compressor
Hoeveelheid koelmiddel
Schuimmiddel

Snel-vriesfunctie, ECO, Temperatuuralarm
Ja
Ja
Akoestisch en visueel
Ja
Elektronisch
1
R600a
Variabele toeren
45 g
Cyclopentaan

Prestaties/Energie label - Reg. 2019



Annual energy consumption 282 KWh/jaar

Geluidsniveau 41 dB(A) re 1pW







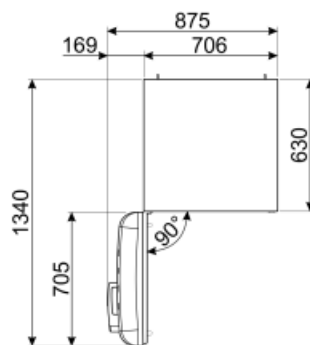
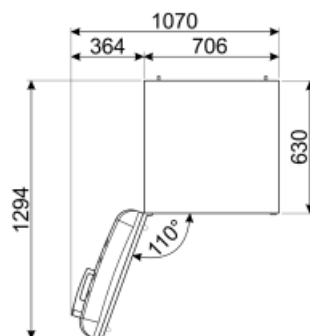
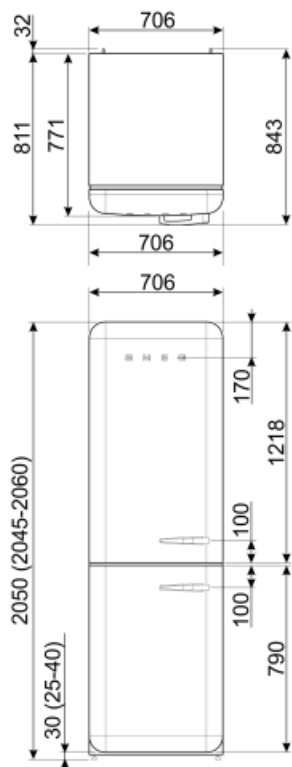





Energie-efficiëntieklasse	E	Conserveringsduur zonder stroom	14 h
Emissieklasse voor akoestisch luchtgeluid	C	4 star - Freezing capacity	8 Kg/24h
Totaal netto volume	481 l	Klimaatklasse	SN, N, ST, T
Netto inhoud vriesgedeelte	137 l	EEl	98 %
Netto inhoud koelgedeeltes	344 l		

Elektrische aansluiting

Stekker	(F;E) Schuko	Spanning (V)	220-240 V
Nominale aansluitwaarde	127 W	Frequentie (Hz)	50/60 Hz
Stroom (A)	1,1 A	Lengte stroomkabel	180 cm



Symbols glossary (TT)

 <p>4 stars freezing compartment for better food preservation.</p>	 <p>A++: Energy efficiency class A++ helps to save up to 20% energy compared to class A. Maximum performance with minimum consumption is guaranteed.</p>
 <p>Smeg Active Ion system improves the quality of the air inside the cell. Thanks to the generation of negatively charged ions released inside the fridge Active Ion system neutralizes unpleasant dust.</p>	 <p>The automatic defrost system works by automatically defrosting at regular intervals eliminating the need to defrost altogether.</p>
 <p>LED display: to show programmes, functions and options selected and the time to the end of the cycle.</p>	 <p>Economical mode: Analyzes fridge functioning during the activation and optimizes the operating cycle in order to reduce power consumption.</p>
 <p>Geventileerd: een geforceerde verdeling van koude lucht in het koelkast compartiment, die een gelijke temperatuurverdeling verzekert in de koelkast.</p>	 <p>Fast freezing: The fast freezing function brings the temperature of the compartment down when activated a few hours prior to usage.</p>
 <p>LED interior lighting: is a more energy efficient and long lasting way of illuminating the interior of the appliance.</p>	 <p>Life Plus 0°C: The temperature in the Lifeplus compartments is kept at 0°C, which preserves fresh meat and fish longer.</p>
 <p>De evolutie van Smeg vaatwassers naar meer intelligente en milieuvriendelijke modellen heeft ertoe geleid om de inverter technologie te gebruiken, die een significante energie- en geluidsbesparing met zich meebrengt.</p>	 <p>Air plus: keeps food fresher for longer.</p>
 <p>Energie-efficiëntieklasse</p>	