

FAB38LBL6



Product familie	Koelkast
Installatie	Vrijstaand
Categorie	Koel-vriescombinatie
Referentie breedte	60 - 70 cm cm
Referentie hoogte	Hoger dan 200 cm cm
No Frost systeem	Totaal No-Frost
Type koelen	Dubbel koelsysteem
Ontdooien	Automatisch ontdooien
Type scharnier	Standaard
Positie scharnier	Links
EAN-code	8017709348571



Design



Design	50's Style	Materiaal zijwanden	Staal
Kleur	Zwart	Kleur zijkanten	Zwart
Design	Bol	Logo	Geassembleerd
Afwerking	Glanzend	Kleur profielen binnenzijde	Zilver
Materiaal deur	Thermisch gevormd kunststof	Kleur profielen laden	Zilver
Handgreep	Extern	Kleur profiel glazen leggers	Zilver
Type handgreep	Vast	Display	LED
Kleur handgreep	Chroom	Positie display	Interno (cella frigo)
Kleur logo	Chroom		

Uitrusting koelkast



Number of compartments	2	Type afdekplaat groente-/fruitlade	Glas
Compartment types	Low temperature compartment, Fruit and vegetable compartment	Aantal lampen	2
Aantal verstelbare leggers	3	Convertible temperature drawer	No
Aantal groente-/fruitlades	1	Low temperature compartment	Ja
Shelves material	Glas	Binnenverlichting koelkast	Ja
Type afdekplaat groente-/fruitlade	Op telescopische geleiders	Type binnenverlichting koelkast	LED

Afdekplaat
groentenlade Ja

Binnendeur koelkast

Aantal verstelbare
binnendeurcompartimenten 3

Aantal flessenhouders 1

Overige features koelkast



Humidity Control Yes, manual
MultiFlow Ja

Ventilator Ja

Uitrusting vriezer

Aantal lades 2

Aantal legplanken 2

Aantal compartimenten met klep 1

Type leggers Glas

Overige features vriezer



Ice maker Manueel ontdooien

Snel-vriescompartiment Ja

Overige technische eigenschappen



Display functies
Snel-vriestoets
Indicator (lampje) temperatuuralarm
Alarm open deur
Temperature Alarm
Type temperatuurcontrole
Aantal compressoren
Type koelgas
Type compressor
Hoeveelheid koelmiddel
Schuimmiddel

Snel-vriesfunctie, ECO, Temperatuuralarm
Ja
Ja
Akoestisch en visueel
Ja
Elektronisch
1
R600a
Variabele toeren
62 g
Cyclopentaan

Prestaties/Energie label - Reg. 2019

 Annual energy consumption 230 kWh/jaar

Geluidsniveau 37 dB(A) re 1 pW

Energie-efficiëntieklasse	D	Conserveringsduur zonder stroom	14 h
Emissieklasse voor akoestisch luchtgeluid	C	4 star - Freezing capacity	8 kg/24h
Totaal netto volume	481 l	Klimaatklasse	SN, N, ST, T
Netto inhoud vriesgedeelte	137 l	EEl	80 %
Netto inhoud koelgedeeltes	344 l		

Elektrische aansluiting

Nominale aansluitwaarde	127 W	Frequentie (Hz)	50/60 Hz
Stroom (A)	1,1 A	Lengte stroomkabel	180 cm
Spanning (V)	220-240 V	Stekker	(F;E) Schuko

Logistieke informatie

Breedte product (mm)	706 mm	Diepte toestel met handvat	811 mm
Diepte zonder handvat en spacer	771 mm	Diepte toestel met deuren open 90°	1340 mm
Maximum hoogte	2050 mm	Diepte uitsparing	32 mm
Product breedte met maximale deuropening	1070 mm		

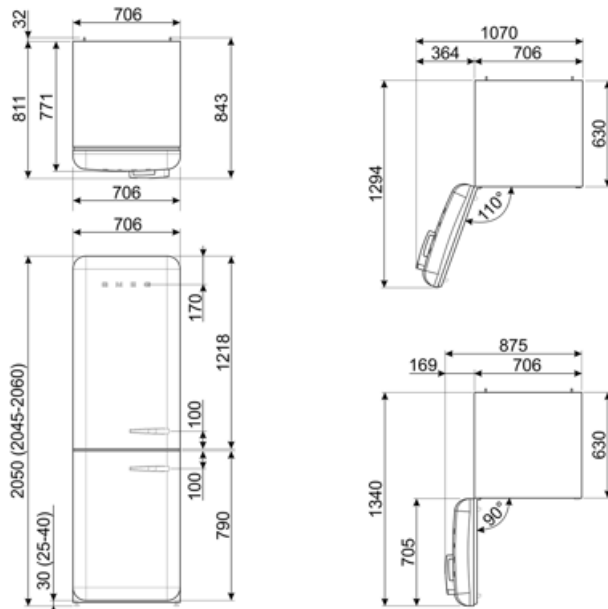











Alternative products



FAB38LCR6

Positie scharnier: Links
Crème

Symbols glossary

-  4 stars freezing compartment for better food preservation.
-  The automatic defrost system works by automatically defrosting at regular intervals eliminating the need to defrost altogether.
-  Economical mode: Analyzes fridge functioning during the activation and optimizes the operating cycle in order to reduce power consumption.
-  Fast freezing: The fast freezing function brings the temperature of the compartment down when activated a few hours prior to usage.
-  De evolutie van Smeg vaatwassers naar meer intelligente en milieuvriendelijke modellen heeft ertoe geleid om de inverter technologie te gebruiken, die een significante energie- en geluidsbesparing met zich meebrengt.
-  Energie-efficiëntieklasse
-  A++: Energy efficiency class A++ helps to save up to 20% energy compared to class A. Maximum performance with minimum consumption is guaranteed.
-  LED display: to show programmes, functions and options selected and the time to the end of the cycle.
-  Geventileerd: een geforceerde verdeling van koude lucht in het koelkast compartiment, die een gelijke temperatuurverdeling verzekert in de koelkast.
-  LED interior lighting: is a more energy efficient and long lasting way of illuminating the interior of the appliance.
-  Multiflow Cooling System: the Multiflow ventilation system allows an even distribution of cool air around the fridge cabinet.