

FAB38LCR



Product Family	Refrigerator
Installation	Free Standing
Category	Bottom Mount
Cooling type	Total No Frost - Double Cooling system
Defrost	Automatic
Hinge type	Standard
Hinge position	Left
EAN code	8017709283537



Aesthetics



Aesthetics	50's Style	Side material	Steel
Colour	Cream	Side colour	Cream
Finishing	Gloss	Logo	Applied
Design	Rounded	Door shelves profile colour	Silver
Material	Heat-moulded	Drawers profile colour	Silver
Handle	External	Colour of glass shelf profile	Silver
Handle type	Fixed	Display	LED
Handle colour	Chrome	Display position	Interior
Logo colour	Chrome	Colori disponibili	Black

Refrigerator compartment features



No. of adjustable shelves	3	Type of crisper/vegetable drawers cover	Glass
Number of fruit and vegetables drawers	1	Life Plus zone-0°C	0°C
Type of adjustable shelves	Glass	Internal light in fridge	Yes
Type of crisper/vegetable drawers cover	On sliding rails	Type of internal light (fridge)	LED
Crisper Cover	Yes		

Refrigerator Inner Door

Number of adjustable door shelves	3	No. of bottle shelves	1
-----------------------------------	---	-----------------------	---

Other Refrigerator features



MultiFlow Fan	Yes	Ionizer	Yes
	Yes		

Freezer compartment features

Number of drawers	2	No. of compartments with flap	1
No. of shelves	2	Type of shelves	Glass

Other Freezer features



Manual ice maker	Yes	Fast freezing compartment	Yes
Ice maker	Manual		

Other technical features



Functions display	Fast freezing, ECO, Temperature alarm
Fast freezing button	Yes
Temperature alarm lamp	Yes
Door open alarm	Acoustic and visual
Temperature Alarm	Yes
Type of temperature control	Electronic
No. of compressors	1
Refrigerant gas type	R600a
Type of compressor	Variable Speed Compressor
Refrigerant Quantity (gr)	43 g
Foam agent	Cyclopentane

Performance / Energy Label



Annual energy consumption	371 KWh/year	Noise level	42 dB(A) re 1 pW
Energy efficiency class	G	Thaw time	14 h







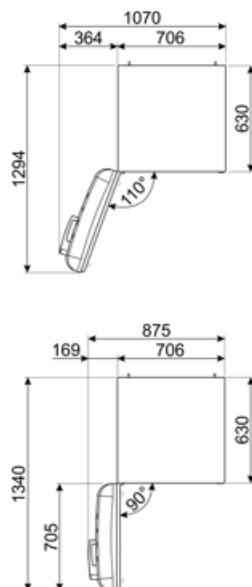
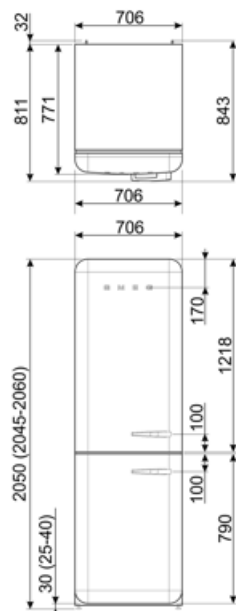





Airborne acoustical noise emission class	D	4 star - Freezing capacity	8 Kg/24h
Total volume	481 l	Climatic class	SN, N, ST, T
Sum of the volumes of the frozen compartment(s)	137 l	EEl	129 %
Sum of the volumes of the chill compartment(s) and the unfrozen compartment(s)	344 l		

Electrical Connection

Plug	(F;E) Schuko	Voltage (V)	220-240 V
Nominal power	127 W	Frequency (Hz)	50/60 Hz
Current	1.27 A	Power supply cable length	180 cm



Symbols glossary

 <p>4 stars freezing compartment for better food preservation.</p>	 <p>Smeg Active Ion system improves the quality of the air inside the cell. Thanks to the generation of negatively charged ions released inside the fridge Active Ion system neutralizes unpleasant dust.</p>
 <p>A++: Energy efficiency class A++ helps to save up to 20% energy compared to class A. Maximum performance with minimum consumption is guaranteed.</p>	 <p>The automatic defrost system works by automatically defrosting at regular intervals eliminating the need to defrost altogether.</p>
 <p>LED display: to show programmes, functions and options selected and the time to the end of the cycle.</p>	 <p>Economical mode: Analyzes fridge functioning during the activation and optimizes the operating cycle in order to reduce power consumption.</p>
 <p>Ventilated: Forced distribution of cold air in the refrigerator compartment, which allows even temperature distribution within the fridge.</p>	 <p>Fast freezing: The fast freezing function brings the temperature of the compartment down when activated a few hours prior to usage.</p>
 <p>LED interior lighting: is a more energy efficient and long lasting way of illuminating the interior of the appliance.</p>	 <p>Life Plus 0°C: The temperature in the Lifeplus compartments is kept at 0°C, which preserves fresh meat and fish longer.</p>
 <p>Inverter technology: The evolution of Smeg's driers towards more intelligent and environmentally sustainable models has led to the choice of using Inverter technology with heat pumps, which reduces significantly energy consumption.</p>	 <p>Air plus: keeps food fresher for longer.</p>
 <p>Energy efficiency class G</p>	