

FAB38LCR5



Product Family	Refrigerator
Installation	Free Standing
Category	Bottom Mount
Reference width	60 - 70
Reference height	Higher than 200
No-Frost system	Total
Cooling type	Total No Frost - Double Cooling system
Defrost	Automatic
Hinge type	Standard
Hinge position	Left
EAN code	8017709297862



Aesthetics



Aesthetics	50's Style	Side material	Steel
Colour	Cream	Side colour	Cream
Finishing	Gloss	Logo	Applied
Design	Rounded	Door shelves profile colour	Silver
Material	Heat-moulded	Drawers profile colour	Silver
Handle	External	Colour of glass shelf profile	Silver
Handle type	Fixed	Display	LED
Handle colour	Chrome	Display position	Interior
Logo colour	Chrome		

Refrigerator compartment features



No. of adjustable shelves	3	Type of crisper/vegetable drawers cover	Glass
Number of fruit and vegetables drawers	1	Life Plus zone-0°C	0°C
Type of adjustable shelves	Glass	Internal light in fridge	Yes
Type of crisper/vegetable drawers cover	On sliding rails	Type of internal light (fridge)	LED
Crisper Cover	Yes		

Refrigerator Inner Door

Number of adjustable door shelves	3	No. of bottle shelves	1
-----------------------------------	---	-----------------------	---

Other Refrigerator features



MultiFlow

Yes

Fan

Yes

Freezer compartment features

Number of drawers	2	No. of compartments with flap	1
No. of shelves	2	Type of shelves	Glass

Other Freezer features



Manual ice maker
Ice maker

Yes
Manual

Fast freezing
compartment

Yes

Other technical features



Functions display

Fast freezing, ECO, Temperature alarm

Fast freezing button

Yes

Temperature alarm lamp

Yes

Door open alarm

Acoustic and visual

Temperature Alarm

Yes

Type of temperature control

Electronic

No. of compressors

1

Refrigerant gas type

R600a

Type of compressor

Variable Speed Compressor

Refrigerant Quantity (gr)

45 g

Foam agent

Cyclopentane

Performance / Energy Label NEW



Annual energy consumption	282 kWh/year	Noise level	41 dB(A) re 1pW
Energy efficiency class	E	Thaw time	14 h
Airborne acoustical noise emission class	C	4 star - Freezing capacity	8 Kg/24h
Total volume	481 l	Climatic class	SN, N, ST, T
		EEl	98 %

Sum of the volumes of the frozen compartment(s) 137 l







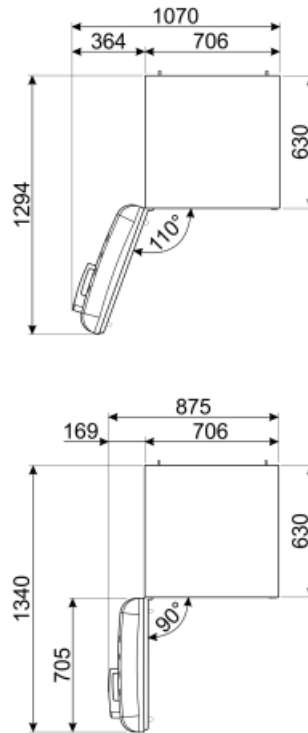
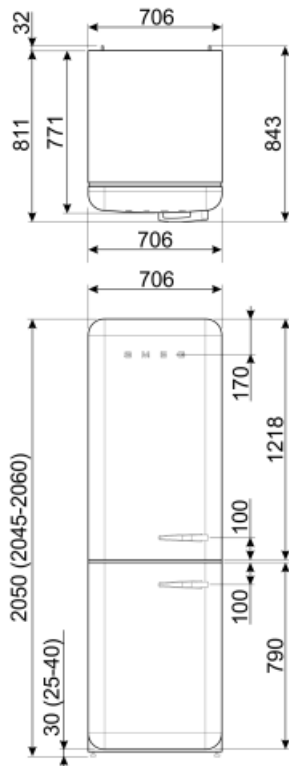





Sum of the volumes of the chill compartment(s) and the unfrozen compartment(s) 344 l

Electrical Connection

Plug	(F;E) Schuko	Voltage (V)	220-240 V
Nominal power	127 W	Frequency (Hz)	50/60 Hz
Current	1,1 A	Power supply cable length	180 cm



Symbols glossary

	4 stars freezing compartment for better food preservation.		A++: Energy efficiency class A++ helps to save up to 20% energy compared to class A. Maximum performance with minimum consumption is guaranteed.
	The automatic defrost system works by automatically defrosting at regular intervals eliminating the need to defrost altogether.		LED display: to show programmes, functions and options selected and the time to the end of the cycle.
	Economical mode: Analyzes fridge functioning during the activation and optimizes the operating cycle in order to reduce power consumption.		Ventilated: Forced distribution of cold air in the refrigerator compartment, which allows even temperature distribution within the fridge.
	Fast freezing: The fast freezing function brings the temperature of the compartment down when activated a few hours prior to usage.		LED interior lighting: is a more energy efficient and long lasting way of illuminating the interior of the appliance.
	Life Plus 0°C: The temperature in the Lifeplus compartments is kept at 0°C, which preserves fresh meat and fish longer.		Inverter technology: The evolution of Smeg's driers towards more intelligent and environmentally sustainable models has led to the choice of using Inverter technology with heat pumps, which reduces significantly energy consumption.
	Air plus: keeps food fresher for longer.		Energy efficiency class E