

## FAB38LCR5



Product familie	Koelkast
Installatie	Vrijstaand
Categorie	Koel-vriescombinatie
Reference width	60 - 70
Reference height	Higher than 200
No Frost systeem	Totaal No-Frost
Type koelen	Dubbel koelsysteem
Ontdooien	Automatisch ontdooien
Type scharnier	Standaard
Positie scharnier	Links
EAN-code	8017709297862



## Design



Design	50's Style	Materiaal zijwanden	Staal
Kleur	Crème	Kleur zijkanten	Crème
Afwerking	Glanzend	Logo	Geassembleerd
Design	Bol	Kleur profielen binnenzijde	Zilver
Materiaal deur	Thermisch gevormd kunststof	Kleur profielen laden	Zilver
Handgreep	Extern	Kleur profiel glazen leggers	Zilver
Type handgreep	Vast	Display	LED
Kleur handgreep	Chroom	Positie display	Interno (cella frigo)
Kleur logo	Chroom		

## Uitrusting koelkast



Aantal verstelbare leggers	3	Type afdekplaat groente-/fruitlade	Glas
Aantal groente-/fruitlades	1	Life Plus zone 0°C	0°C
Type verstelbare leggers	Glas	Binnenverlichting koelkast	Ja
Type afdekplaat groente-/fruitlade	Op telescopische geleiders	Type binnenverlichting koelkast	LED
Afdekplaat groentenlade	Ja		

## Binnendeur koelkast

Aantal verstelbare binnendeurcompartimenten	3	Aantal flessenhouders	1
---	---	-----------------------	---

## Overige features koelkast



MultiFlow Ventilator	Ja	Active Ion technology	Ja
----------------------	----	-----------------------	----

## Uitrusting vriezer

Aantal lades	2	Aantal compartimenten met klep	1
Aantal legplanken	2	Type leggers	Glas

## Overige features vriezer



Ijsmaker (manueel) Ice maker	Ja Manueel ontdooien	Snel-vriescompartiment	Ja
---------------------------------	-------------------------	------------------------	----

## Overige technische eigenschappen



Display functies	Snel-vriesfunctie, ECO, Temperatuuralarm
Snel-vriestoets	Ja
Indicator (lampje) temperatuuralarm	Ja
Alarm open deur	Akoestisch en visueel
Temperature Alarm	Ja
Type temperatuurcontrole	Elektronisch
Aantal compressoren	1
Type koelgas	R600a
Type compressor	Variabele toeren
Hoeveelheid koelmiddel	45 g
Schuimmiddel	Cyclopentaan

## Prestaties/Energie label - Reg. 2019



Annual energy consumption	282 KWh/jaar	Geluidsniveau	41 dB(A) re 1pW
---------------------------	--------------	---------------	-----------------







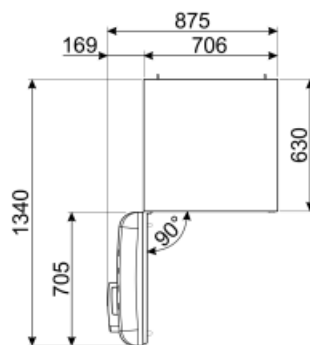
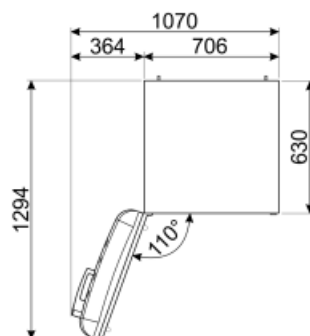
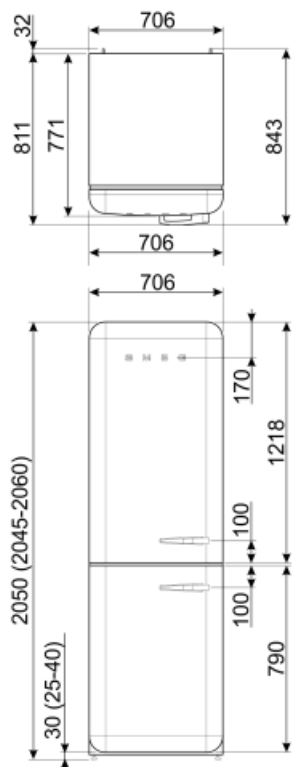





<b>Energie-efficiëntieklasse</b>	<b>E</b>	<b>Conserveringsduur zonder stroom</b>	<b>14 h</b>
<b>Emissieklasse voor akoestisch luchtgeluid</b>	<b>C</b>	<b>4 star - Freezing capacity</b>	<b>8 Kg/24h</b>
<b>Totaal netto volume</b>	<b>481 l</b>	<b>Klimaatklasse</b>	<b>SN, N, ST, T</b>
<b>Netto inhoud vriesgedeelte</b>	<b>137 l</b>	<b>EEL</b>	<b>98 %</b>
<b>Netto inhoud koelgedeeltes</b>	<b>344 l</b>		

## Elektrische aansluiting

<b>Stekker</b>	<b>(F;E) Schuko</b>	<b>Spanning (V)</b>	<b>220-240 V</b>
<b>Nominale aansluitwaarde</b>	<b>127 W</b>	<b>Frequentie (Hz)</b>	<b>50/60 Hz</b>
<b>Stroom (A)</b>	<b>1.1 A</b>	<b>Lengte stroomkabel</b>	<b>180 cm</b>



## Symbols glossary (TT)

 <p>4 stars freezing compartment for better food preservation.</p>	 <p>Smeg Active Ion system improves the quality of the air inside the cell. Thanks to the generation of negatively charged ions released inside the fridge Active Ion system neutralizes unpleasant dust.</p>
 <p>The automatic defrost system works by automatically defrosting at regular intervals eliminating the need to defrost altogether.</p>	 <p>LED display: to show programmes, functions and options selected and the time to the end of the cycle.</p>
 <p>Economical mode: Analyzes fridge functioning during the activation and optimizes the operating cycle in order to reduce power consumption.</p>	 <p>Energie-efficiëntieklasse</p>
 <p>A++: Energy efficiency class A++ helps to save up to 20% energy compared to class A. Maximum performance with minimum consumption is guaranteed.</p>	 <p>Geventileerd: een geforceerde verdeling van koude lucht in het koelkast compartiment, die een gelijke temperatuurverdeling verzekert in de koelkast.</p>
 <p>Fast freezing: The fast freezing function brings the temperature of the compartment down when activated a few hours prior to usage.</p>	 <p>LED interior lighting: is a more energy efficient and long lasting way of illuminating the interior of the appliance.</p>
 <p>Life Plus 0°C: The temperature in the Lifeplus compartments is kept at 0°C, which preserves fresh meat and fish longer.</p>	 <p>De evolutie van Smeg vaatwassers naar meer intelligente en milieuvriendelijke modellen heeft ertoe geleid om de inverter technologie te gebruiken, die een significante energie- en geluidsbesparing met zich meebrengt.</p>
 <p>Air plus: keeps food fresher for longer.</p>	