

FAB38LCR6



Product familie	Koelkast
Installatie	Vrijstaand
Categorie	Koel-vriescombinatie
Referentie breedte	60 - 70 cm cm
Referentie hoogte	Hoger dan 200 cm cm
No Frost systeem	Totaal No-Frost
Type koelen	Dubbel koelsysteem
Ontdooien	Automatisch ontdooien
Type scharnier	Standaard
Positie scharnier	Links
EAN-code	8017709348595



Design



Design	50's Style	Materiaal zijwanden	Staal
Kleur	Crème	Kleur zijkanten	Crème
Design	Bol	Logo	Geassembleerd
Afwerking	Glanzend	Kleur profielen binnenzijde	Zilver
Materiaal deur	Thermisch gevormd kunststof	Kleur profielen laden	Zilver
Handgreep	Extern	Kleur profiel glazen leggers	Zilver
Type handgreep	Vast	Display	LED
Kleur handgreep	Chroom	Positie display	Interno (cella frigo)
Kleur logo	Chroom		

Uitrusting koelkast



Number of compartments	2	Type afdekplaat groente-/fruitlade	Glas
Compartment types	Low temperature compartment, Fruit and vegetable compartment	Aantal lampen	2
Aantal verstelbare leggers	3	Convertible temperature drawer	No
Aantal groente-/fruitlades	1	Low temperature compartment	Ja
Shelves material	Glas	Binnenverlichting koelkast	Ja
Type afdekplaat groente-/fruitlade	Op telescopische geleiders	Type binnenverlichting koelkast	LED

Afdekplaat groentenlade Ja

Binnendeur koelkast

Aantal verstelbare binnendeurcompartimenten 3 Aantal flessenhouders 1

Overige features koelkast



Humidity Control Yes, manual Ventilator Ja
MultiFlow Ja

Uitrusting vriezer

Aantal lades 2 Aantal compartimenten met klep 1
Aantal legplanken 2 Type leggers Glas

Overige features vriezer



Ice maker Manueel ontdooien Snel-vriescompartiment Ja

Overige technische eigenschappen



Display functies	Snel-vriesfunctie, ECO, Temperatuuralarm
Snel-vriestoets	Ja
Indicator (lampje) temperatuuralarm	Ja
Alarm open deur	Akoestisch en visueel
Temperature Alarm	Ja
Type temperatuurcontrole	Elektronisch
Aantal compressoren	1
Type koelgas	R600a
Type compressor	Variabele toeren
Hoeveelheid koelmiddel	62 g
Schuimmiddel	Cyclopentaan

Prestaties/Energie label - Reg. 2019



Annual energy consumption 230 kWh/jaar Geluidsniveau 37 dB(A) re 1 pW

Energie-efficiëntieklasse	D	Conserveringsduur zonder stroom	14 h
Emissieklasse voor akoestisch luchtgeluid	C	4 star - Freezing capacity	8 kg/24h
Totaal netto volume	481 l	Klimaatklasse	SN, N, ST, T
Netto inhoud vriesgedeelte	137 l	EEl	80 %
Netto inhoud koelgedeeltes	344 l		

Elektrische aansluiting

Nominale aansluitwaarde	127 W	Frequentie (Hz)	50/60 Hz
Stroom (A)	1,1 A	Lengte stroomkabel	180 cm
Spanning (V)	220-240 V	Stekker	(F;E) Schuko

Logistieke informatie

Breedte product (mm)	706 mm	Diepte toestel met handvat	811 mm
Diepte zonder handvat en spacer	771 mm	Diepte toestel met deuren open 90°	1340 mm
Maximum hoogte	2050 mm	Diepte uitsparing	32 mm
Product breedte met maximale deuropening	1070 mm		

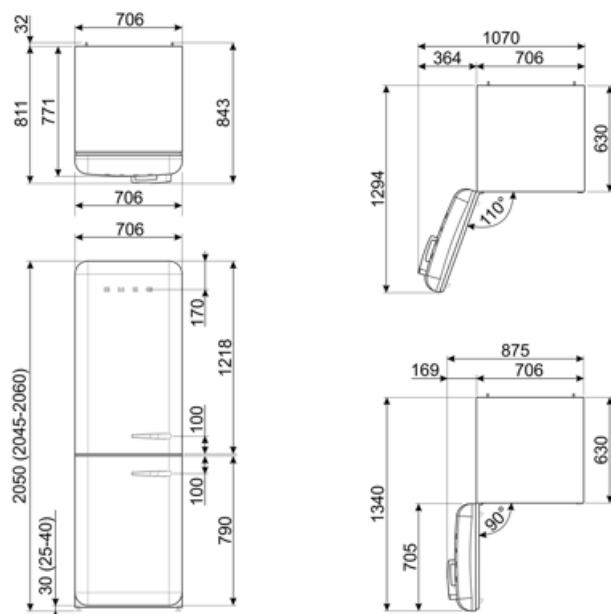











Alternative products



FAB38LBL6

Positie scharnier: Links
Zwart

Symbols glossary

-  4 stars freezing compartment for better food preservation.
-  The automatic defrost system works by automatically defrosting at regular intervals eliminating the need to defrost altogether.
-  Economical mode: Analyzes fridge functioning during the activation and optimizes the operating cycle in order to reduce power consumption.
-  Fast freezing: The fast freezing function brings the temperature of the compartment down when activated a few hours prior to usage.
-  De evolutie van Smeg vaatwassers naar meer intelligente en milieuvriendelijke modellen heeft ertoe geleid om de inverter technologie te gebruiken, die een significante energie- en geluidsbesparing met zich meebrengt.
-  Energie-efficiëntieklasse
-  A++: Energy efficiency class A++ helps to save up to 20% energy compared to class A. Maximum performance with minimum consumption is guaranteed.
-  LED display: to show programmes, functions and options selected and the time to the end of the cycle.
-  Geventileerd: een geforceerde verdeling van koude lucht in het koelkast compartiment, die een gelijke temperatuurverdeling verzekert in de koelkast.
-  LED interior lighting: is a more energy efficient and long lasting way of illuminating the interior of the appliance.
-  Multiflow Cooling System: the Multiflow ventilation system allows an even distribution of cool air around the fridge cabinet.