

FAB38RPG5



Product familie	Koelkast
Installatie	Vrijstaand
Categorie	Koel-vriescombinatie
Referentie breedte	60 - 70 cm
Referentie hoogte	Hoger dan 200 cm
No Frost systeem	Totaal No-Frost
Type koelen	Dubbel koelsysteem
Ontdooien	Automatisch ontdooien
Type scharnier	Standaard
Positie scharnier	Rechts
EAN-code	8017709297909



Design



Design	50's Style	Materiaal zijwanden	Staal
Kleur	Pastelgroen	Kleur zijkanten	Watergroen
Afwerking	Glanzend	Logo	Geassembleerd
Design	Bol	Kleur profielen binnenzijde	Zilver
Materiaal deur	Thermisch gevormd kunststof	Kleur profielen laden	Zilver
Handgreep	Extern	Kleur profiel glazen leggers	Zilver
Type handgreep	Vast	Display	LED
Kleur handgreep	Chroom	Positie display	Interno (cella frigo)
Kleur logo	Chroom		

Uitrusting koelkast



Aantal verstelbare leggers	3	Type afdekplaat groente-/fruitlade	Glas
Aantal groente-/fruitlades	1	Life Plus zone 0°C	Ja
Type verstelbare leggers	Glas	Binnenverlichting koelkast	Ja
Type afdekplaat groente-/fruitlade	Op telescopische geleiders	Type binnenverlichting koelkast	LED
Afdekplaat groentenlade	Ja		

Binnendeur koelkast

Aantal verstelbare binnendeurcompartimenten	3	Aantal flessenhouders	1
---	---	-----------------------	---

Overige features koelkast



MultiFlow	Ja	Ventilator	Ja
-----------	----	------------	----

Uitrusting vriezer

Aantal lades	2	Aantal compartimenten met klep	1
Aantal legplanken	2	Type leggers	Glas

Overige features vriezer



Ijsmaker (manueel)	Ja	Snel-vriescompartiment	Ja
Ice maker	Manueel ontdooien		

Overige technische eigenschappen



Display functies	Snel-vriestoeets	Snel-vriestoeets	Snel-vriestoeets
Snel-vriestoeets	Indicator (lampje) temperatuuralarm	Indicator (lampje) temperatuuralarm	Indicator (lampje) temperatuuralarm
Indicator (lampje) temperatuuralarm	Alarm open deur	Alarm open deur	Alarm open deur
Alarm open deur	Temperature Alarm	Temperature Alarm	Temperature Alarm
Temperature Alarm	Type temperatuurcontrole	Type temperatuurcontrole	Type temperatuurcontrole
Type temperatuurcontrole	Aantal compressoren	Aantal compressoren	Aantal compressoren
Aantal compressoren	Type koelgas	Type koelgas	Type koelgas
Type koelgas	Type compressor	Type compressor	Type compressor
Type compressor	Hoeveelheid koelmiddel	Hoeveelheid koelmiddel	Hoeveelheid koelmiddel
Hoeveelheid koelmiddel	Schuimmiddel	Schuimmiddel	Schuimmiddel

Prestaties/Energie label - Reg. 2019

	Annual energy consumption	282 KWh/jaar	Geluidsniveau	41 dB(A) re 1pW
	Energie-efficiëntieklasse	E	Conserveringsduur zonder stroom	14 h







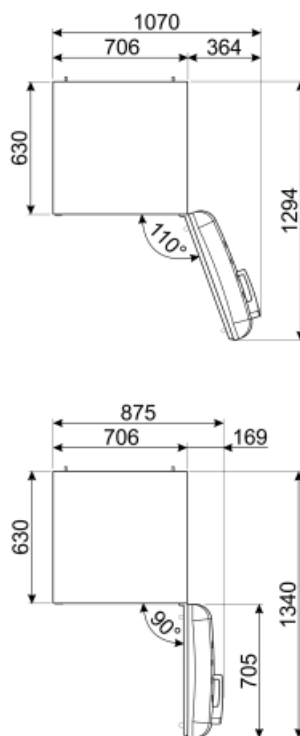
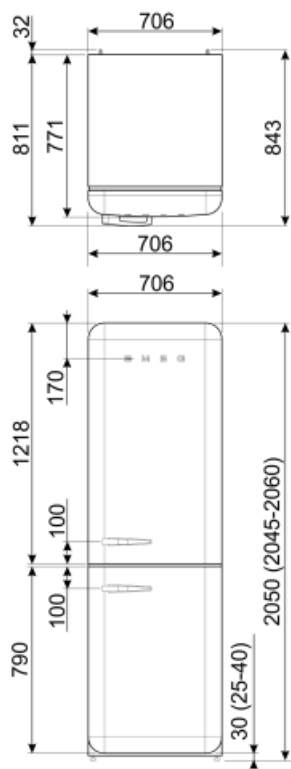





Emissieklasse voor akoestisch luchtgeluid	C	4 star - Freezing capacity	8 Kg/24h
Totaal netto volume	481 l	Klimaatklasse	SN, N, ST, T
Netto inhoud vriesgedeelte	137 l	EEl	98 %
Netto inhoud koelgedeeltes	344 l		

Elektrische aansluiting

Stekker	(F;E) Schuko	Spanning (V)	220-240 V
Nominale aansluitwaarde	127 W	Frequentie (Hz)	50/60 Hz
Stroom (A)	1.1 A	Lengte stroomkabel	180 cm



Symbols glossary (TT)

	4 stars freezing compartment for better food preservation.		
	The automatic defrost system works by automatically defrosting at regular intervals eliminating the need to defrost altogether.		LED display: to show programmes, functions and options selected and the time to the end of the cycle.
	Economical mode: Analyzes fridge functioning during the activation and optimizes the operating cycle in order to reduce power consumption.		Geventileerd: een geforceerde verdeling van koude lucht in het koelkast compartiment, die een gelijke temperatuurverdeling verzekert in de koelkast.
	Fast freezing: The fast freezing function brings the temperature of the compartment down when activated a few hours prior to usage.		LED interior lighting: is a more energy efficient and long lasting way of illuminating the interior of the appliance.
	Life Plus 0°C: The temperature in the Lifeplus compartments is kept at 0°C, which preserves fresh meat and fish longer.		De evolutie van Smeg vaatwassers naar meer intelligente en milieuvriendelijke modellen heeft ertoe geleid om de inverter technologie te gebruiken, die een significante energie- en geluidsbesparing met zich meebrengt.
	Multiflow Cooling System: the Multiflow ventilation system allows an even distribution of cool air around the fridge cabinet.		Energie-efficiëntieklasse