

# FAB38ULCR



Product Family	Refrigerator
Installation	Free standing
Category	Bottom Mount
Sistema Total No - Frost	Total
Cooling type	Total No Frost - Double Cooling system
Defrost	Automatic
Hinge type	Standard
Hinge position	Left
EAN code	8017709291433



## Aesthetics



Aesthetic	50's Style	Logo	Applied
Colour	Cream	Door shelves profile color	Silver
Finishing	Glossy	Drawers profile color	Silver
Design	Rounded	Color of glass shelf profile	Silver
Handle colour	Chrome	Display	LED
Side material	Steel	Display position	Interno (cella frigo)
Side colour	Cream	Alternative colours available	Pastel blue, White, Black, Cream, Red, Pastel green

## Refrigerator compartment features



No. of adjustable shelves	3	Type of crisper/vegetable drawers cover	Glass
Number of fruit and vegetables drawers	1	Life Plus zone-0°C	-2°C +3 °C
Type of adjustable shelves	Glass	Internal light in fridge	Yes
Type of crisper/vegetable drawers cover	On sliding rails	Type of internal light (fridge)	LED
Crisper Cover	Yes		

## Refrigerator Inner Door

Number of adjustable door shelves	3	No. of bottle shelves	1
-----------------------------------	---	-----------------------	---

## Other Refrigerator features



MultiFlow	Yes	Ionizer	Yes
Fan	Yes		

## Freezer compartment features

Number of drawers	2	No. of compartments with flap	1
No. of shelves	2	Type of shelves	Glass

## Other Freezer features



Manual ice maker	Yes	Fast freezing compartment	Yes
Ice maker	Manual		

## Other technical features



Functions display	Fast freezing, ECO, Temperature alarm
Fast freezing button	Yes
Temperature alarm lamp	Yes
Door open alarm	Acoustic and visual
Temperature Alarm	Yes
Type of temperature control	Electronic
No. of compressors	1
Refrigerant gas type	R600a
Type of compressor	Inverter
Refrigerant Quantity (gr)	1.5 oz
Foam agent	Cyclopentane

## Performance / Energy Label - Reg. 2019

Airborne acoustical noise emissions	42 dB(A) re 1pW	Climate class	SN, N, ST, T
-------------------------------------	-----------------	---------------	--------------

## Electrical Connection

Plug	(A) USA e Messico	Frequency (Hz)	60 Hz
Current	2.3 A		

Voltage (V)







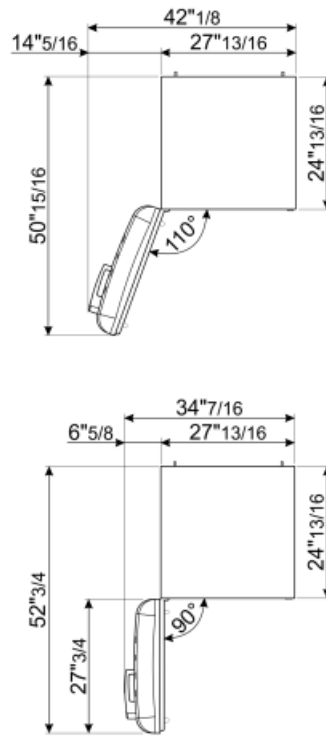
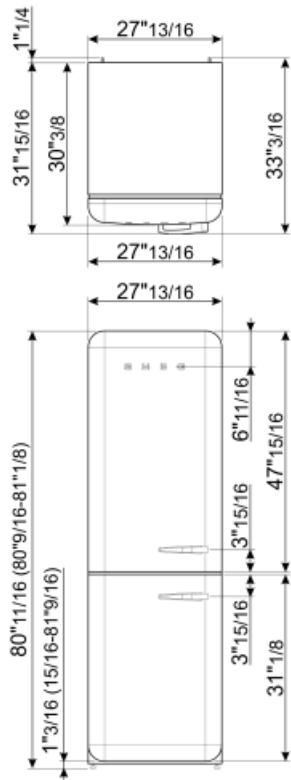



120 V

Power supply cable length

70 7/8 "



## Symbols glossary (TT)

	Smeg Active Ion system improves the quality of the air inside the cell. Thanks to the generation of negatively charged ions released inside the fridge Active Ion system neutralizes unpleasant dust.		The automatic defrost system works by automatically defrosting at regular intervals eliminating the need to defrost altogether.
	LED display: to show programmes, functions and options selected and the time to the end of the cycle.		Economical mode: Analyzes fridge functioning during the activation and optimizes the operating cycle in order to reduce power consumption.
	Ventilated: Forced distribution of cold air in the refrigerator compartment, which allows even temperature distribution within the fridge.		Fast freezing: The fast freezing function brings the temperature of the compartment down when activated a few hours prior to usage.
	LED interior lighting: is a more energy efficient and long lasting way of illuminating the interior of the appliance.		Life Plus 0°C: The temperature in the Lifeplus compartments is kept at 0°C, which preserves fresh meat and fish longer.
	Smeg's evolution towards more intelligent and eco-friendly models has led to the choice of Inverter technology, which significantly reduces consumption.		Air plus: keeps food fresher for longer.