

# FAB50LBL5



|                    |                       |
|--------------------|-----------------------|
| Product familie    | Koelkast              |
| Installatie        | Vrijstaand            |
| Categorie          | Koel-vriescombinatie  |
| Referentie breedte | 70 - 80 cm            |
| Type koelen        | Dubbel koelsysteem    |
| Ontdooien          | Automatisch ontdooien |
| Type scharnier     | Standaard             |
| Positie scharnier  | Links                 |
| EAN-code           | 8017709297619         |



## Design



|                 |                             |                              |                       |
|-----------------|-----------------------------|------------------------------|-----------------------|
| Design          | 50's Style                  | Materiaal zijwanden          | Staal                 |
| Kleur           | Zwart                       | Kleur zijkanten              | Zwart                 |
| Afwerking       | Glanzend                    | Logo                         | Geassembleerd         |
| Design          | Bol                         | Kleur profielen binnenzijde  | Zilver                |
| Materiaal deur  | Thermisch gevormd kunststof | Kleur profielen laden        | Zilver                |
| Handgreep       | Extern                      | Kleur profiel glazen leggers | Chroom                |
| Type handgreep  | Vast                        | Display                      | LED                   |
| Kleur handgreep | Chroom                      | Positie display              | Interno (cella frigo) |
| Kleur logo      | Chroom                      |                              |                       |

## Uitrusting koelkast



|                                    |           |                                    |      |
|------------------------------------|-----------|------------------------------------|------|
| Aantal verstelbare leggers         | 2         | Type afdekplaat groente-/fruitlade | Glas |
| Aantal groente-/fruitlades         | 1         | Life Plus zone 0°C                 | Ja   |
| Type verstelbare leggers           | Glas      | Binnenverlichting koelkast         | Ja   |
| Type afdekplaat groente-/fruitlade | Standaard | Type binnenverlichting koelkast    | LED  |
| Afdekplaat groentenlade            | Ja        |                                    |      |

## Binnendeur koelkast

Aantal verstelbare  
binnendeurcompartimenten 3

Aantal flessenhouders 1

## Overige features koelkast



MultiFlow

Ja

Ventilator

Ja

## Uitrusting vriezer

Aantal legplanken 1

Binnenverlichting  
vriezer Ja

Type verlichting vriezer LED

Type leggers Glas

## Binnendeur vriezer

Aantal  
binnendeurcompartimenten 2

## Overige features vriezer



Ijsmaker (manueel)  
Ice maker

Ja

Manueel ontdooien

Snel-vriescompartiment Ja

## Overige technische eigenschappen



Display functies

Snel-vriestoets

Alarm open deur

Type temperatuurcontrole

Aantal compressoren

Type koelgas

Type compressor

Hoeveelheid koelmiddel

Schuimmiddel

Snel-vriesfunctie, ECO, Temperatuuralarm

Ja

Akoestisch en visueel

Elektronisch

1

R600a

Variabele toeren

62 g

Cyclopentaan

## Prestaties/Energie label - Reg. 2019









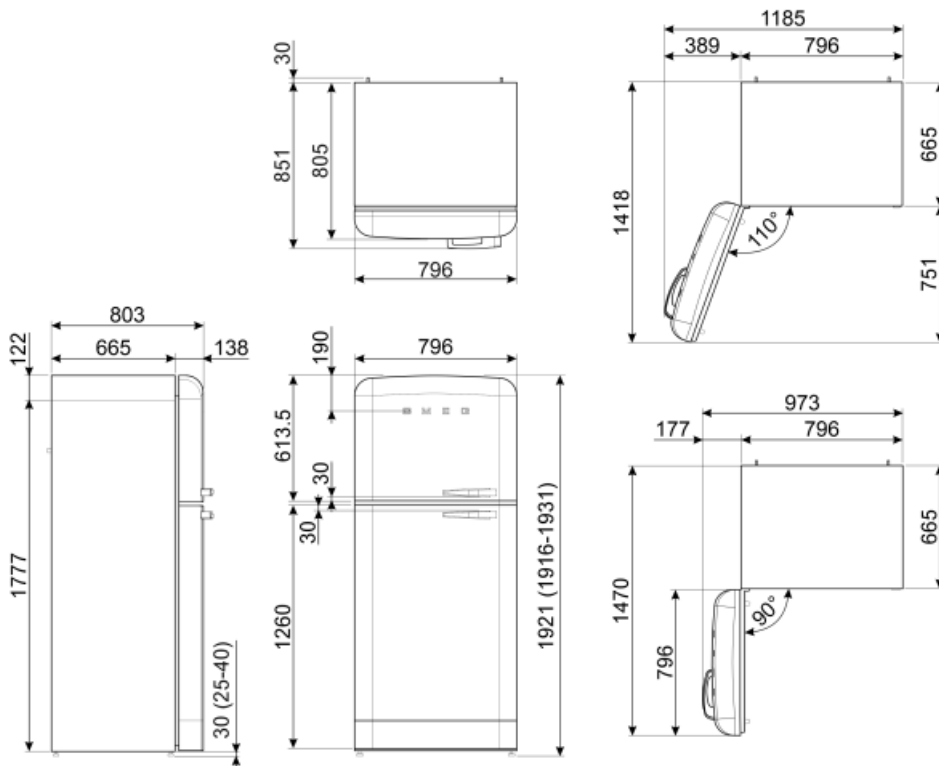





|   |              |                                 |                 |
|---|--------------|---------------------------------|-----------------|
| Annual energy consumption                 | 265 kWh/jaar | Geluidsniveau                   | 41 dB(A) re 1pW |
| Energie-efficiëntieklasse                 | E            | Conserveringsduur zonder stroom | 15 h            |
| Emissieklasse voor akoestisch luchtgeluid | C            | 4 star - Freezing capacity      | 8 Kg/24h        |
| Totaal netto volume                       | 524 l        | Klimaatklasse                   | SN, N, ST, T    |
| Netto inhoud vriesgedeelte                | 124 l        | EEL                             | 96 %            |
| Netto inhoud koelgedeeltes                | 400 l        |                                 |                 |

## Elektrische aansluiting

|                         |              |                    |           |
|-------------------------|--------------|--------------------|-----------|
| Stekker                 | (F;E) Schuko | Spanning (V)       | 220-240 V |
| Nominale aansluitwaarde | 197 W        | Frequentie (Hz)    | 50/60 Hz  |
| Stroom (A)              | 1.1 A        | Lengte stroomkabel | 180 cm    |



## Symbols glossary (TT)

|  |  |   |  |
|--|--|---|--|
|    | 4 stars freezing compartment for better food preservation.   |    |  |
|    | The automatic defrost system works by automatically defrosting at regular intervals eliminating the need to defrost altogether.            |    | LED display: to show programmes, functions and options selected and the time to the end of the cycle.  |
|    | Economical mode: Analyzes fridge functioning during the activation and optimizes the operating cycle in order to reduce power consumption. |    | Geventileerd: een geforceerde verdeling van koude lucht in het koelkast compartiment, die een gelijke temperatuurverdeling verzekert in de koelkast.   |
|    | Fast freezing: The fast freezing function brings the temperature of the compartment down when activated a few hours prior to usage.        |    | LED interior lighting: is a more energy efficient and long lasting way of illuminating the interior of the appliance.  |
|    | Life Plus 0°C: The temperature in the Lifeplus compartments is kept at 0°C, which preserves fresh meat and fish longer.                    |    | De evolutie van Smeg vaatwassers naar meer intelligente en milieuvriendelijke modellen heeft ertoe geleid om de inverter technologie te gebruiken, die een significante energie- en geluidsbesparing met zich meebrengt. |
|  | Multiflow Cooling System: the Multiflow ventilation system allows an even distribution of cool air around the fridge cabinet.              |  | Energie-efficiëntieklasse  |