

FAB50RCR5



Product familie	Koelkast
Installatie	Vrijstaand
Categorie	Koel-vriescombinatie
Referentie breedte	70 - 80 cm cm
No Frost systeem	Ja
Type koelen	Dubbel koelsysteem
Ontdooien	Automatisch ontdooien
Type scharnier	Standaard
Positie scharnier	Rechts
EAN-code	8017709299392



Design



Design	50's Style	Materiaal zijwanden	Staal
Kleur	Crème	Kleur zijkanten	Crème
Design	Bol	Logo	Geassembleerd
Afwerking	Glanzend	Kleur profielen binnenzijde	Zilver
Materiaal deur	Thermisch gevormd kunststof	Kleur profielen laden	Zilver
Handgreep	Extern	Kleur profiel glazen leggers	Chroom
Type handgreep	Vast	Display	LED
Kleur handgreep	Chroom	Positie display	Interno (cella frigo)
Kleur logo	Chroom		

Uitrusting koelkast



Number of compartments	2	Afdekplaat groentenlade	Ja
Compartment types	Low temperature compartment, Fruit and vegetable compartment	Type afdekplaat groente-/fruitlade	Glas
Aantal verstelbare leggers	2	Low temperature compartment	Ja
Aantal groente-/fruitlades	1	Binnenverlichting koelkast	Ja
Shelves material	Glas	Type binnenverlichting koelkast	LED
Type afdekplaat groente-/fruitlade	Standaard		

Binnendeur koelkast

Aantal verstelbare binnendeurcompartimenten	3	Aantal flessenhouders	1
---	---	-----------------------	---

Overige features koelkast



Humidity Control	Yes, manual	Ventilator	Ja
MultiFlow	Ja		

Uitrusting vriezer

Aantal legplanken	1	Type verlichting vriezer	LED
Binnenverlichting vriezer	Ja	Type leggers	Glas

Binnendeur vriezer

Aantal binnendeurcompartimenten	2
---------------------------------	---

Overige features vriezer



Ice maker	Manueel ontdooien	Snel-vriescompartiment	Ja
-----------	-------------------	------------------------	----

Overige technische eigenschappen



Display functies	Snel-vriesfunctie, ECO, Temperatuuralarm
Snel-vriestoets	Ja
Alarm open deur	Akoestisch en visueel
Temperature Alarm	Ja
Type temperatuurcontrole	Elektronisch
Aantal compressoren	1
Type koelgas	R600a
Type compressor	Variabele toeren
Hoeveelheid koelmiddel	62 g
Schuimmiddel	Cyclopentaan

Prestaties/Energie label - Reg. 2019



Annual energy consumption	265 kWh/jaar	Geluidsniveau	41 dB(A) re 1 pW
Energie-efficiëntieklasse	E	Conserveringsduur zonder stroom	15 h
Emissieklasse voor akoestisch luchtgeluid	C	4 star - Freezing capacity	8 kg/24h
Totaal netto volume	524 l	Klimaatklasse	SN, N, ST, T
Netto inhoud vriesgedeelte	124 l	EEl	96 %
Netto inhoud koelgedeeltes	400 l		

Elektrische aansluiting

Nominale aansluitwaarde	197 W	Frequentie (Hz)	50/60 Hz
Stroom (A)	1,1 A	Lengte stroomkabel	180 cm
Spanning (V)	220-240 V	Stekker	(F;E) Schuko

Logistieke informatie

Breedte product (mm)	796 mm	Product breedte met maximale deuropening	1185 mm
Diepte zonder handvat en spacer	805 mm	Diepte toestel met handvat	851 mm
Maximum hoogte	1921 mm	Diepte toestel met deuren open 90°	1470 mm

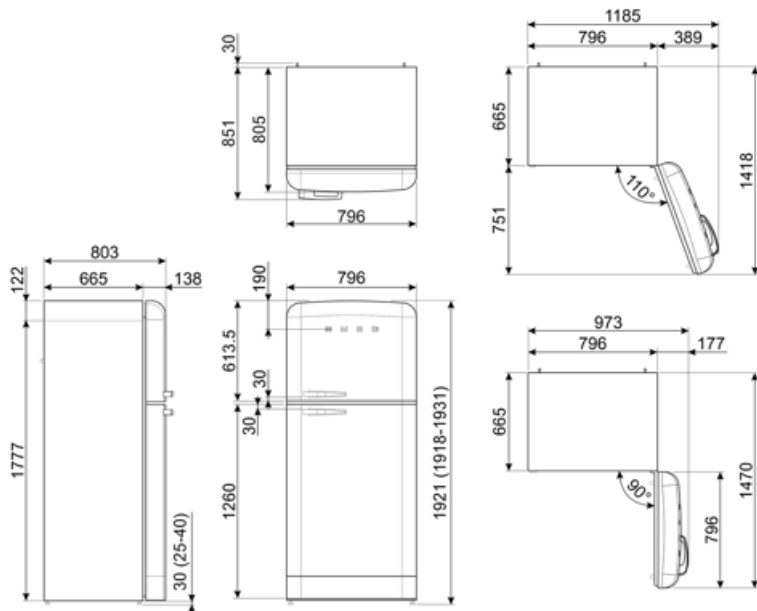

Alternative products



FAB50RPG5

Positie scharnier: Rechts
Pastelgroen



FAB50RPB5

Positie scharnier: Rechts
Pastelblauw



FAB50RCRB5

Positie scharnier: Rechts
Crème



FAB50RBL5

Positie scharnier: Rechts
Zwart



FAB50RRD5











Positie scharnier: Rechts
Rood



FAB50RWH5

Positie scharnier: Rechts
Wit

Symbols glossary

-  4 stars freezing compartment for better food preservation.
-  The automatic defrost system works by automatically defrosting at regular intervals eliminating the need to defrost altogether.
-  Economical mode: Analyzes fridge functioning during the activation and optimizes the operating cycle in order to reduce power consumption.
-  Fast freezing: The fast freezing function brings the temperature of the compartment down when activated a few hours prior to usage.
-  De evolutie van Smeg vaatwassers naar meer intelligente en milieuvriendelijke modellen heeft ertoe geleid om de inverter technologie te gebruiken, die een significante energie- en geluidsbesparing met zich meebrengt.
-  Energie-efficiëntieklasse
-  A++: Energy efficiency class A++ helps to save up to 20% energy compared to class A. Maximum performance with minimum consumption is guaranteed.
-  LED display: to show programmes, functions and options selected and the time to the end of the cycle.
-  Geventileerd: een geforceerde verdeling van koude lucht in het koelkast compartiment, die een gelijke temperatuurverdeling verzekert in de koelkast.
-  LED interior lighting: is a more energy efficient and long lasting way of illuminating the interior of the appliance.
-  Multiflow Cooling System: the Multiflow ventilation system allows an even distribution of cool air around the fridge cabinet.