

FAB50RPB5



Product familie	Koelkast
Installatie	Vrijstaand
Categorie	Koel-vriescombinatie
Reference width	70 - 80
Type koelen	Dubbel koelsysteem
Ontdooien	Automatisch ontdooien
Type scharnier	Standaard
Positie scharnier	Rechts
EAN-code	8017709299415



Design



Design	50's Style	Materiaal zijwanden	Staal
Kleur	Pastelblauw	Kleur zijkanten	Pastelblauw
Afwerking	Glanzend	Logo	Geassembleerd
Design	Bol	Kleur profielen binnenzijde	Zilver
Materiaal deur	Thermisch gevormd kunststof	Kleur profielen laden	Zilver
Handgreep	Extern	Kleur profiel glazen leggers	Chroom
Type handgreep	Vast	Display	LED
Kleur handgreep	Chroom	Positie display	Interno (cella frigo)
Kleur logo	Chroom		

Uitrusting koelkast



Aantal verstelbare leggers	2	Type afdekplaat groente-/fruitlade	Glas
Aantal groente-/fruitlades	1	Life Plus zone 0°C	Ja
Type verstelbare leggers	Glas	Binnenverlichting koelkast	Ja
Type afdekplaat groente-/fruitlade	Standaard	Type binnenverlichting koelkast	LED
Afdekplaat groentenlade	Ja		

Binnendeur koelkast

Aantal verstelbare
binnendeurcompartimenten 3

Aantal flessenhouders 1

Overige features koelkast



MultiFlow Ja

Active Ion technology Ja

Ventilator Ja

Uitrusting vriezer

Aantal legplanken 1

Type verlichting vriezer LED

Binnenverlichting
vriezer Ja

Type leggers Glas

Binnendeur vriezer

Aantal
binnendeurcompartimenten 2

Overige features vriezer



Ijsmaker (manueel) Ja

Snel-vriescompartiment Ja

Ice maker Manueel ontdooien

Overige technische eigenschappen



Display functies

Snel-vriesfunctie, ECO, Temperatuuralarm

Snel-vriestoets

Ja

Alarm open deur

Akoestisch en visueel

Type temperatuurcontrole

Elektronisch

Aantal compressoren

1

Type koelgas

R600a

Type compressor

Variabele toeren

Hoeveelheid koelmiddel

62 g

Schuimmiddel

Cyclopentaan

Prestaties/Energie label - Reg. 2019









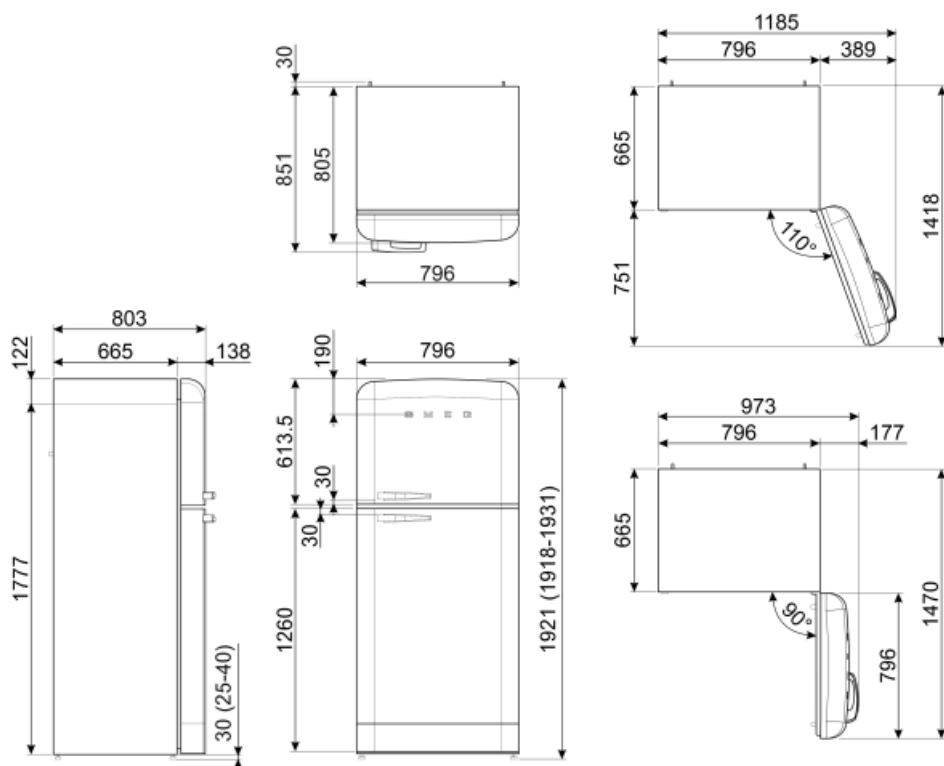





Annual energy consumption	265 KWh/jaar	Geluidsniveau	41 dB(A) re 1pW
Energie-efficiëntieklasse	E	Conserveringsduur zonder stroom	15 h
Emissieklasse voor akoestisch luchtgeluid	C	4 star - Freezing capacity	8 Kg/24h
Totaal netto volume	524 l	Klimaatklasse	SN, N, ST, T
Netto inhoud vriesgedeelte	124 l	EEl	96 %
Netto inhoud koelgedeeltes	400 l		

Elektrische aansluiting

Stekker	(F;E) Schuko	Spanning (V)	220-240 V
Nominale aansluitwaarde	197 W	Frequentie (Hz)	50/60 Hz
Stroom (A)	1,1 A	Lengte stroomkabel	200 cm



Symbols glossary (TT)

 <p>4 stars freezing compartment for better food preservation.</p>	 <p>Smeg Active Ion system improves the quality of the air inside the cell. Thanks to the generation of negatively charged ions released inside the fridge Active Ion system neutralizes unpleasant dust.</p>
 <p>The automatic defrost system works by automatically defrosting at regular intervals eliminating the need to defrost altogether.</p>	 <p>LED display: to show programmes, functions and options selected and the time to the end of the cycle.</p>
 <p>Economical mode: Analyzes fridge functioning during the activation and optimizes the operating cycle in order to reduce power consumption.</p>	 <p>Energie-efficiëntieklasse</p>
 <p>A++: Energy efficiency class A++ helps to save up to 20% energy compared to class A. Maximum performance with minimum consumption is guaranteed.</p>	 <p>Geventileerd: een geforceerde verdeling van koude lucht in het koelkast compartiment, die een gelijke temperatuurverdeling verzekert in de koelkast.</p>
 <p>Fast freezing: The fast freezing function brings the temperature of the compartment down when activated a few hours prior to usage.</p>	 <p>LED interior lighting: is a more energy efficient and long lasting way of illuminating the interior of the appliance.</p>
 <p>Life Plus 0°C: The temperature in the Lifeplus compartments is kept at 0°C, which preserves fresh meat and fish longer.</p>	 <p>De evolutie van Smeg vaatwassers naar meer intelligente en milieuvriendelijke modellen heeft ertoe geleid om de inverter technologie te gebruiken, die een significante energie- en geluidsbesparing met zich meebrengt.</p>
 <p>Air plus: keeps food fresher for longer.</p>	