

FAB50RPG5



Product Family	Refrigerator
Installation	Free standing
Category	Top Mount
Reference width	70 - 80 cm
Sistema Total No - Frost	Yes
Cooling type	Total No Frost - Double Cooling system
Defrost	Automatic
Hinge type	Standard
Hinge position	Right
EAN code	8017709299422



Aesthetics



Aesthetic	50's Style	Side material	Steel
Colour	Pastel green	Side colour	Pastel green
Design	Rounded	Logo	Applied
Finishing	Glossy	Door shelves profile color	Silver
Material	Heat-moulded	Drawers profile color	Silver
Handle	External	Color of glass shelf profile	Chrome
Handle type	Fixed	Display	LED
Handle colour	Chrome	Display position	Interno (cella frigo)
Logo colour	Chrome		

Refrigerator compartment features



Number of compartments	2	Crisper Cover	Yes
Compartment types	Low temperature compartment, Fruit and vegetable compartment	Type of crisper/vegetable drawers cover	Glass
No. of adjustable shelves	2	Low temperature compartment	Yes
Number of fruit and vegetables drawers	1	Internal light in fridge	Yes
Shelves material	Glass	Type of internal light (fridge)	LED

Type of crisper/vegetable drawers cover Standard

Refrigerator Inner Door

Number of adjustable door shelves 3 No. of bottle shelves 1

Other Refrigerator features



Humidity Control Yes, manual Fan Yes
MultiFlow Yes

Freezer compartment features

No. of shelves 1 Type of internal light (freezer) LED
Internal light in freezer Yes Type of shelves Glass

Freezer Inner Door

No. of adjustable door shelves 2

Other Freezer features



Ice maker Manual Fast freezing compartment Yes

Other technical features



Functions display Fast freezing, ECO, Temperature alarm
Fast freezing button Yes
Door open alarm Acoustic and visual
Temperature Alarm Yes
Type of temperature control Electronic
No. of compressors 1
Refrigerant gas type R600a
Type of compressor Inverter
Refrigerant Quantity (g) 62 g
Foam agent Cyclopentane

Performance / Energy Label - Reg. 2019

			
Annual energy consumption	265 kWh/a	Airborne acoustical noise emissions	41 dB(A) re 1 pW
Energy efficiency class	E	Temperature Rise Time	15 h
Airborne acoustical noise emission class	C	4 star - Freezing capacity	8 kg/24h
Total net volume	524 l	Climate class	SN, N, ST, T
Sum of the volumes of the frozen compartment(s)	124 l	EEL	96 %
Sum of the volumes of the chill compartment(s) and the unfrozen compartment(s)	400 l		

Electrical Connection

Electrical connection rating	197 W	Frequency (Hz)	50/60 Hz
Current	1,1 A	Power supply cable length	180 cm
Voltage (V)	220-240 V	Plug	(F;E) Schuko

Logistic Information

Width	796 mm	Product width with maximum doors opening	1185 mm
Depth without handle	805 mm	Product depth with handle	851 mm
Height	1921 mm	Product depth with doors open at 90°	1470 mm

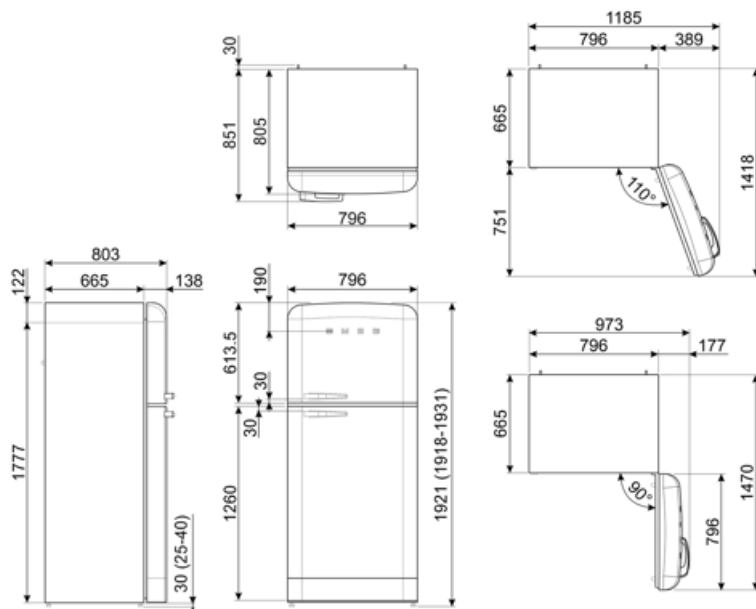

Alternative products



FAB50RBL5

Hinge position: Right
Black



FAB50RRD5

Hinge position: Right
Red



FAB50RCR5

Hinge position: Right
Cream



FAB50RPB5

Hinge position: Right
Pastel blue



FAB50RCRB5











Hinge position: Right
Cream



FAB50RWH5

Hinge position: Right
White

Symbols glossary

-  4 stars freezing compartment for better food preservation.
-  A++: Energy efficiency class A++ helps to save up to 20% energy compared to class A. Maximum performance with minimum consumption is guaranteed.
-  LED display: to show programmes, functions and options selected and the time to the end of the cycle.
-  Ventilated: Forced distribution of cold air in the refrigerator compartment, which allows even temperature distribution within the fridge.
-  LED interior lighting: is a more energy efficient and long lasting way of illuminating the interior of the appliance.
-  Multiflow Cooling System: the Multiflow ventilation system allows an even distribution of cool air around the fridge cabinet.
-  The automatic defrost system works by automatically defrosting at regular intervals eliminating the need to defrost altogether.
-  Energy efficiency class E
-  Economical mode: Analyzes fridge functioning during the activation and optimizes the operating cycle in order to reduce power consumption.
-  Fast freezing: The fast freezing function brings the temperature of the compartment down when activated a few hours prior to usage.
-  Smeg's evolution towards more intelligent and eco-friendly models has led to the choice of Inverter technology, which significantly reduces consumption.