

# FAB50RRD5



<b>Product Family</b>	Refrigerator
<b>Installation</b>	Free standing
<b>Category</b>	Top Mount
<b>Reference width</b>	70 - 80 cm
<b>Sistema Total No - Frost</b>	Yes
<b>Cooling type</b>	Total No Frost - Double Cooling system
<b>Defrost</b>	Automatic
<b>Hinge type</b>	Standard
<b>Hinge position</b>	Right
<b>EAN code</b>	8017709299439



## Aesthetics



<b>Aesthetic</b>	50's Style	<b>Side material</b>	Steel
<b>Colour</b>	Red	<b>Side colour</b>	Red
<b>Design</b>	Rounded	<b>Logo</b>	Applied
<b>Finishing</b>	Glossy	<b>Door shelves profile color</b>	Silver
<b>Material</b>	Heat-moulded	<b>Drawers profile color</b>	Silver
<b>Handle</b>	External	<b>Color of glass shelf profile</b>	Chrome
<b>Handle type</b>	Fixed	<b>Display</b>	LED
<b>Handle colour</b>	Chrome	<b>Display porition</b>	Interno (cella frigo)
<b>Logo colour</b>	Chrome		

## Refrigerator compartment features



<b>Number of compartments</b>	2	<b>Crisper Cover</b>	Yes
<b>Compartment types</b>	Low temperature compartment, Fruit and vegetable compartment	<b>Type of crisper/vegetable drawers cover</b>	Glass
<b>No. of adjustable shelves</b>	2	<b>Low temperature compartment</b>	Yes
<b>Number of fruit and vegetables drawers</b>	1	<b>Internal light in fridge</b>	Yes
<b>Shelves material</b>	Glass	<b>Type of internal light (fridge)</b>	LED

Type of crisper/vegetable drawers cover Standard

## Refrigerator Inner Door

Number of adjustable door shelves 3 No. of bottle shelves 1

## Other Refrigerator features



Humidity Control Yes, manual Fan Yes  
MultiFlow Yes

## Freezer compartment features

No. of shelves 1 Type of internal light (freezer) LED  
Internal light in freezer Yes Type of shelves Glass

## Freezer Inner Door

No. of adjustable door shelves 2

## Other Freezer features



Ice maker Manual Fast freezing compartment Yes

## Other technical features



Functions display Fast freezing, ECO, Temperature alarm  
Fast freezing button Yes  
Door open alarm Acoustic and visual  
Temperature Alarm Yes  
Type of temperature control Electronic  
No. of compressors 1  
Refrigerant gas type R600a  
Type of compressor Inverter  
Refrigerant Quantity (g) 62 g  
Foam agent Cyclopentane

## Performance / Energy Label - Reg. 2019

<b>Annual energy consumption</b>	265 kWh/a	<b>Airborne acoustical noise emissions</b>	41 dB(A) re 1 pW
<b>Energy efficiency class</b>	E	<b>Temperature Rise Time</b>	15 h
<b>Airborne acoustical noise emission class</b>	C	<b>4 star - Freezing capacity</b>	8 kg/24h
<b>Total net volume</b>	524 l	<b>Climate class</b>	SN, N, ST, T
<b>Sum of the volumes of the frozen compartment(s)</b>	124 l	<b>EEl</b>	96 %
<b>Sum of the volumes of the chill compartment(s) and the unfrozen compartment(s)</b>	400 l		

## Electrical Connection

<b>Electrical connection rating</b>	197 W	<b>Frequency (Hz)</b>	50/60 Hz
<b>Current</b>	1,1 A	<b>Power supply cable length</b>	180 cm
<b>Voltage (V)</b>	220-240 V	<b>Plug</b>	(F;E) Schuko

## Logistic Information

<b>Width</b>	796 mm	<b>Product width with maximum doors opening</b>	1185 mm
<b>Depth without handle</b>	805 mm	<b>Product depth with handle</b>	851 mm
<b>Height</b>	1921 mm	<b>Product depth with doors open at 90°</b>	1470 mm

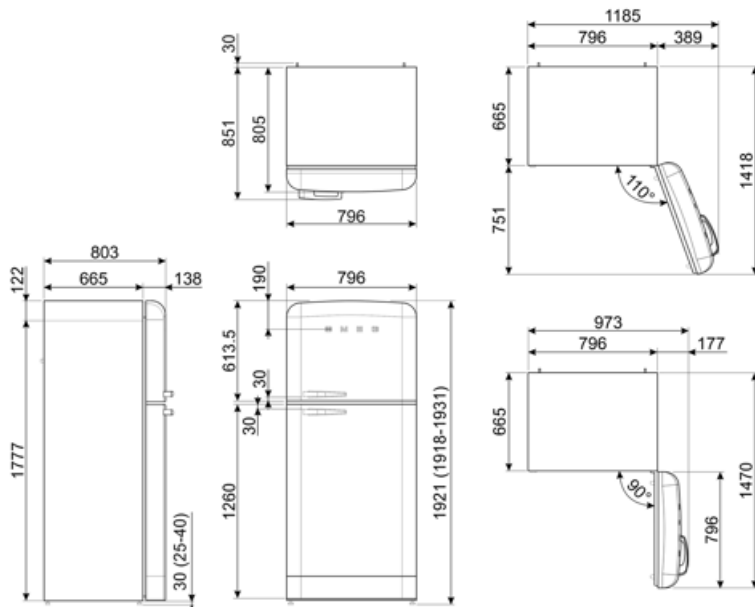

---

## Alternative products

---



**FAB50RPG5**

**Hinge position:** Right  
Pastel green



**FAB50RPB5**

**Hinge position:** Right  
Pastel blue



**FAB50RCR5**

**Hinge position:** Right  
Cream



**FAB50RBL5**

**Hinge position:** Right  
Black



**FAB50RCRB5**











**Hinge position:** Right  
Cream



**FAB50RWH5**

**Hinge position:** Right  
White

## Symbols glossary

-  4 stars freezing compartment for better food preservation.
-  The automatic defrost system works by automatically defrosting at regular intervals eliminating the need to defrost altogether.
-  Economical mode: Analyzes fridge functioning during the activation and optimizes the operating cycle in order to reduce power consumption.
-  Fast freezing: The fast freezing function brings the temperature of the compartment down when activated a few hours prior to usage.
-  Smeg's evolution towards more intelligent and eco-friendly models has led to the choice of Inverter technology, which significantly reduces consumption.
-  Energy efficiency class E
-  A++: Energy efficiency class A++ helps to save up to 20% energy compared to class A. Maximum performance with minimum consumption is guaranteed.
-  LED display: to show programmes, functions and options selected and the time to the end of the cycle.
-  Ventilated: Forced distribution of cold air in the refrigerator compartment, which allows even temperature distribution within the fridge.
-  LED interior lighting: is a more energy efficient and long lasting way of illuminating the interior of the appliance.
-  Multiflow Cooling System: the Multiflow ventilation system allows an even distribution of cool air around the fridge cabinet.