

FAB50URPB3



Product Family	Refrigerator
Installation	Free standing
Category	Double Door
Cooling type	Total No Frost - Double Cooling system
Defrost	Automatic
Hinge position	Right
EAN code	8017709321543



Aesthetics



Aesthetic	50's Style	Side colour	Pastel blue
Colour	Pastel blue	Logo	Applied
Finishing	Glossy	Door shelves profile color	Silver
Handle	External	Drawers profile color	Silver
Handle colour	Chrome	Color of glass shelf profile	Chrome
Logo colour	Chrome	Display	LED
Side material	Steel	Display position	Interno (cella frigo)

Refrigerator compartment features



No. of adjustable shelves	2	Type of crisper/vegetable drawers cover	Glass
Number of fruit and vegetables drawers	1	Life Plus zone-0°C	Yes
Type of adjustable shelves	Glass	Type of internal light (fridge)	LED
Crisper Cover	Yes		

Refrigerator Inner Door

Number of adjustable door shelves	3	No. of bottle shelves	1
-----------------------------------	---	-----------------------	---

Other Refrigerator features



MultiFlow

Yes

Fan

Yes

Freezer compartment features

No. of shelves

1

Internal light in freezer

Yes

Type of internal light
(freezer)

LED

Type of shelves

Glass

Freezer Inner Door

No. of adjustable door
shelves

2

Other Freezer features



Manual ice maker
Ice maker

Yes

Automatic

Fast freezing
compartment

Yes

Other technical features



Functions display

Fast freezing button

Door open alarm

Type of temperature control

No. of compressors

Refrigerant gas type

Type of compressor

Foam agent

Fast freezing, ECO, Temperature alarm

Yes

Acoustic and visual

Electronic

1

R600a

Inverter

Cyclopentane

Performance / Energy Label - Reg. 2019

Annual energy
consumption

453 kWh/year

Sum of the volumes of
the frozen
compartment(s)

4.38 cu. ft.

Total gross volume

19.28 cu. ft.

Airborne acoustical
noise emissions

41 dB(A) re 1 pW

Fresh Food
compartment - Gross
Volume

14.90 cu. ft.

Climate class







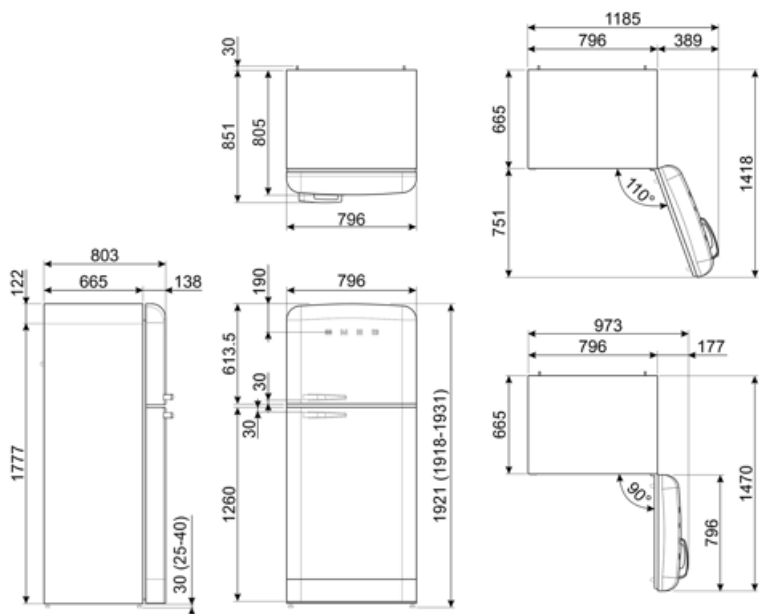





SN, N, ST, T

Electrical Connection

Plug	(A) USA e Messico	Voltage (V)	120 V
Electrical connection rating	197 W	Frequency (Hz)	60 Hz
Current	2.6 A	Power supply cable length	70 7/8 "



Symbols glossary

	4 stars freezing compartment for better food preservation.		The automatic defrost system works by automatically defrosting at regular intervals eliminating the need to defrost altogether.
	A++: Energy efficiency class A++ helps to save up to 20% energy compared to class A. Maximum performance with minimum consumption is guaranteed.		LED display: to show programmes, functions and options selected and the time to the end of the cycle.
	Economical mode: Analyzes fridge functioning during the activation and optimizes the operating cycle in order to reduce power consumption.		Ventilated: Forced distribution of cold air in the refrigerator compartment, which allows even temperature distribution within the fridge.
	Fast freezing: The fast freezing function brings the temperature of the compartment down when activated a few hours prior to usage.		LED interior lighting: is a more energy efficient and long lasting way of illuminating the interior of the appliance.
	Life Plus 0°C: The temperature in the Lifeplus compartments is kept at 0°C, which preserves fresh meat and fish longer.		Smeg's evolution towards more intelligent and eco-friendly models has led to the choice of Inverter technology, which significantly reduces consumption.
	Air plus: keeps food fresher for longer.		Energy efficiency class E