

FAB5RPB5



Product Family	Refrigerator
Installation	Free standing
Category	One Door
Reference width	Until 60 cm
Reference height	Until 100 cm
Cooling type	Static
Defrost	Automatic
Hinge type	Standard
Hinge position	Right
EAN code	8017709299583



Aesthetics

Aesthetic	50's Style	Logo colour	Chrome
Colour	Pastel blue	Side material	Steel
Design	Rounded	Side colour	Pastel blue
Finishing	Glossy	Logo	Applied
Material	Heat-moulded	Door shelves profile color	Chrome
Handle	External	Drawers profile color	Chrome
Handle type	Fixed	Color of glass shelf profile	Chrome
Handle colour	Chrome		

Refrigerator compartment features



No. of adjustable shelves	2	Internal light in fridge	Yes
Shelves material	Glass	Type of internal light (fridge)	LED

Refrigerator Inner Door

Number of adjustable door shelves	1	No. of bottle shelves	1
Adjustable door shelves with wire support	Yes	Bottle shelves with wire support	Yes

Other technical features

Type of temperature control	Electronic
Refrigerant gas type	R600a
Type of compressor	Standard
Refrigerant Quantity (g)	19 g
Foam agent	Cyclopentane

Performance / Energy Label - Reg. 2019

			
Annual energy consumption	61 kWh/a	Sum of the volumes of the chill compartment(s) and the unfrozen compartment(s)	34 l
Energy efficiency class	D	Airborne acoustical noise emissions	40 dB(A) re 1 pW
Airborne acoustical noise emission class	C	Climate class	SN, N, ST, T
Total net volume	34 l	EI	79 %

Electrical Connection

Electrical connection rating	60 W	Frequency (Hz)	50/60 Hz
Current	0,3 A	Power supply cable length	100 cm
Voltage (V)	220-240 V	Plug	(F;E) Schuko

Logistic Information

Width	404 mm	Product depth with handle	570 mm
Depth without handle	500 mm	Product depth with doors open at 90°	800 mm
Height	725 mm	Spacer depth	30 mm
Product width with maximum doors opening	707 mm		

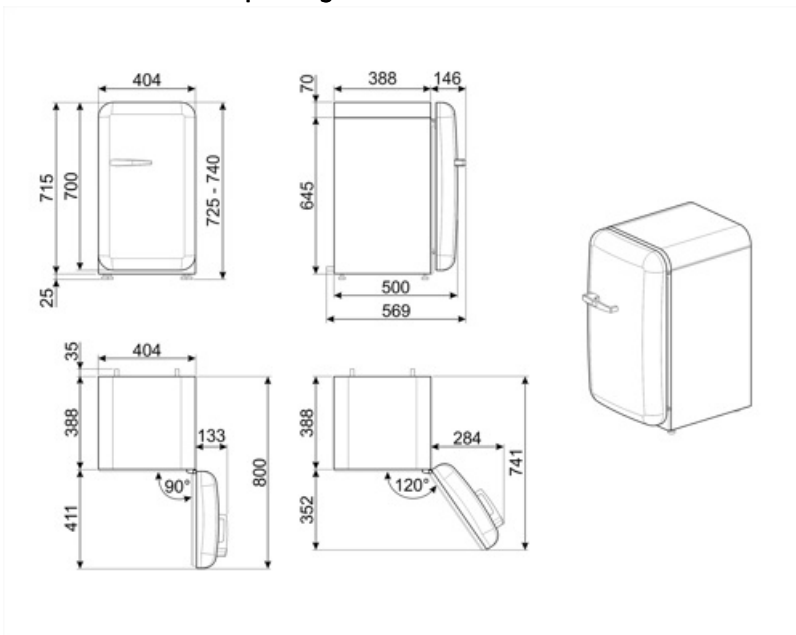

Compatible Accessories

KITCABLE90UK

Cable with IEC connector and UK plug

Alternative products



FAB5RPK5

Hinge position: Right
Pink



FAB5RBL5

Hinge position: Right
Black



FAB5RRD5

Hinge position: Right
Red



FAB5RDUJ5

Hinge position: Right
Decorated / Special



FAB5RSV5

Hinge position: Right
Silver



FAB5RCR5

Hinge position: Right
Cream



FAB5RWH5

Hinge position: Right
White



FAB5RPG5

Hinge position: Right
Pastel green



FAB5ROR5

Hinge position: Right
Orange

Symbols glossary



The automatic defrost system works by automatically defrosting at regular intervals eliminating the need to defrost altogether.



LED interior lighting: is a more energy efficient and long lasting way of illuminating the interior of the appliance.



A+++: Appliances with this symbol can reduce energy consumption by a further 30% from the standard A energy rating.



Energy efficiency class D