

## FC18EN4AX



Product Family	Refrigerator
Installation	Free standing
Category	Bottom Mount
Reference width	Until 60
Sistema Total No - Frost	Total
Cooling type	Total No Frost - Double Cooling system
Defrost	Automatic
Hinge type	Standard
Door opening flush with the wall	Yes
Slot-in	Yes
Hinge position	Right
Reversible door	Yes
EAN code	8017709295752



## Aesthetics



Aesthetic	Universale	Logo colour	Silver
Colour	Stainless steel	Side material	Steel
Finishing	Fingerproof	Side colour	Silver
Design	Flat	Logo	Applied
Material	Stainless steel	Display	LCD Touch
Door steel type	Finger proof	Display position	Esterno (su porta)
Handle	Integrated	Alternative colours available	Effetto Marmo

## Refrigerator compartment features



No. of adjustable shelves	2	Type of crisper/vegetable drawers cover	Glass
Number of fruit and vegetables drawers	1	Life Plus zone-0°C	Yes
Type of adjustable shelves	Glass	Internal light in fridge	Yes
Type of crisper/vegetable drawers cover	On sliding rails	Type of internal light (fridge)	LED
Crisper Cover	Yes		

## Refrigerator Inner Door

No. of bottle shelves	1
-----------------------	---

Number of adjustable door shelves 2

## Other Refrigerator features



Accessories	Egg tray	<b>Fan</b>	Yes
MultiFlow	Yes	<b>Ionizer</b>	Yes

## Freezer compartment features

Number of drawers 3

## Other Freezer features

Accessories 2 ice boxes

## Other technical features



Functions display	Holiday, Fast freezing, Fast cooling, ECO, Control lock, Cooling timer
Door open alarm	Yes
Temperature Alarm	Yes
Type of temperature control	Electronic
No. of compressors	1
Refrigerant gas type	R600a
Type of compressor	Standard
Refrigerant Quantity (gr)	47 g
Foam agent	Cyclopentane

## Performance / Energy Label NEW 2019









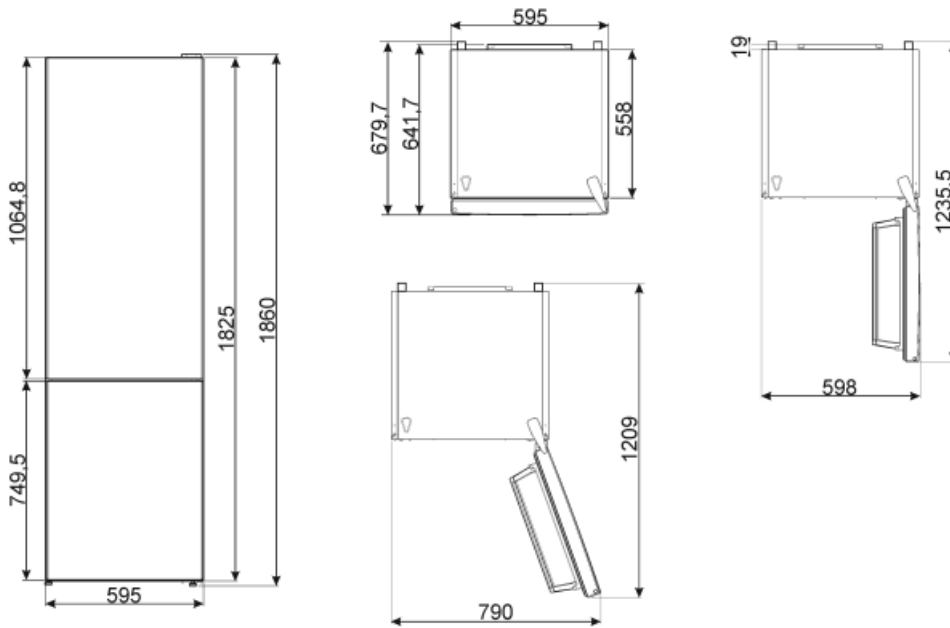









Annual energy consumption	250 kWh/a	Airborne acoustical noise emissions	41 dB(A) re 1pW
Energy efficiency class	E	Temperature Rise Time	11.83 h
Airborne acoustical noise emission class	C	4 star - Freezing capacity	8.0 Kg/24h
Total net volume	330 l	Climate class	SN, T
Sum of the volumes of the frozen compartment(s)	101 l	EEL	100 %
Sum of the volumes of the chill compartment(s) and the unfrozen compartment(s)	230 l		

## Electrical Connection

<b>Plug</b>	(F;E) Schuko	<b>Voltage (V)</b>	220-240 V
<b>Electrical connection rating</b>	197 W	<b>Frequency (Hz)</b>	50 Hz
<b>Current</b>	1,1 A	<b>Power supply cable length</b>	210 cm



## Symbols glossary (TT)

 <p>4 stars freezing compartment for better food preservation.</p>	 <p>Smeg Active Ion system improves the quality of the air inside the cell. Thanks to the generation of negatively charged ions released inside the fridge Active Ion system neutralizes unpleasant dust.</p>
 <p>The automatic defrost system works by automatically defrosting at regular intervals eliminating the need to defrost altogether.</p>	 <p>Child lock: some models are fitted with a device to lock the programme/cycle so it cannot be accidentally changed.</p>
 <p>LCD display: to optimize performance and simplify the use of the appliance.</p>	 <p>Economical mode: Analyzes fridge functioning during the activation and optimizes the operating cycle in order to reduce power consumption.</p>
 <p>A++: Energy efficiency class A++ helps to save up to 20% energy compared to class A. Maximum performance with minimum consumption is guaranteed.</p>	 <p>Ventilated: Forced distribution of cold air in the refrigerator compartment, which allows even temperature distribution within the fridge.</p>
 <p>Fast freezing: The fast freezing function brings the temperature of the compartment down when activated a few hours prior to usage.</p>	 <p>Fingerprint proof stainless steel: Fingerprint proof stainless steel keeps stainless steel looking as good as new.</p>
 <p>Power saving mode: The power saving mode allows you to disable the refrigerator and keep the freezer working.</p>	 <p>LED interior lighting: is a more energy efficient and long lasting way of illuminating the interior of the appliance.</p>
 <p>Life Plus 0°C: The temperature in the Lifeplus compartments is kept at 0°C, which preserves fresh meat and fish longer.</p>	 <p>Air plus: keeps food fresher for longer.</p>
 <p>Slot-in: The refrigerators with Slot-in opening can be perfectly integrated into the furniture structure, as the doors open at 90° do not go beyond the side of the product. In case of installation next to the wall, it will be necessary to consider the dimensions of the handle in order to open the door at 90 °.</p>	 <p>Energy efficiency class E</p>