

## FC18XDNE



Product Family	Refrigerator
Installation	Free Standing
Category	Bottom Mount
Reference width	Until 60 cm
Sistema Total No - Frost	Yes
Cooling type	Total No Frost
Defrost	Automatic
Hinge type	Standard
Handle kit to be ordered separately	No
Door opening flush with the wall	No
Slot-in	No
Hinge position	Right
Reversible door	Yes
EAN code	8017709303129



## Aesthetics



Aesthetic	Universal	Side colour	Silver
Colour	Inox Look	Logotipo	Logotipo aplicado
Material	Steel Effect	Display	LED
Handle	Integrated	Mostrar porções	Externo (na porta)
Handle type	Fixed	Dispenser	No
Logo colour	Chrome	Water Filter	No
Side material	Steel	HomeBar	No

## Refrigerator compartment features



No. of adjustable shelves	2	Type of crisper/vegetable drawers cover	Glass
Number of fruit and vegetables drawers	1	Life Plus zone-0°C	No
Shelves material	Glass	Compartimento baixa temperatura	Yes
Type of crisper/vegetable drawers cover	On sliding rails	Internal light in fridge	Yes
Crisper Cover	Yes	Type of internal light (fridge)	LED
Bottle shelf	Yes		

## Refrigerator Inner Door

Number of adjustable door shelves 2

No. of bottle shelves 1

Adjustable door shelves with wire support No

Bottle shelves with wire support No

## Other Refrigerator features



Accessories Egg tray

Ionizer No

Natural Plus Blu Light No

Tecnologia de titânio No

MultiFlow Yes

Filtro de odor antibacteriano No

Fan No

Zona de cuidados biológicos No

## Freezer compartment features

Number of drawers 3

Internal light in freezer No

## Freezer Inner Door

Pizza box No

## Other Freezer features

Accessories 1 ice box

Fast freezing compartment No

Ice maker No

Ice tray shelf No

## Other technical features



Functions display

Fast freezing, ECO

MultiZone

No

Ligação à rede de água

No

Door open alarm

Yes

Temperature Alarm

Yes

Type of temperature control

Electronic

No. of compressors

1

Refrigerant gas type

R600a

Type of compressor

Standard

Espuma expansiva de isolamento

Ciclopentano

## Etiqueta de Desempenho / Energia - Reg. 2019



<b>Consumo de energia anual</b>	242 kWh/a	<b>Airborne acoustical noise emissions</b>	38 dB(A) re 1 pW
<b>Classe de eficiência energética</b>	E	<b>Autonomia de conservação sem energia elétrica</b>	10 h
<b>Classe de emissão de ruído acústico aerotransportado</b>	C	<b>4 estrelas - Capacidade de congelamento</b>	10,0 kg/24h
<b>Volume líquido total</b>	300 l	<b>Classe climática</b>	SN, N, ST, T
<b>Soma dos volumes do(s) compartimento(s) congelado(s)</b>	96 l	<b>EI</b>	100 %
<b>Soma dos volumes do(s) compartimento(s) refrigerado(s) e do(s) compartimento(s) não congelado(s)</b>	204 l		

## Electrical Connection







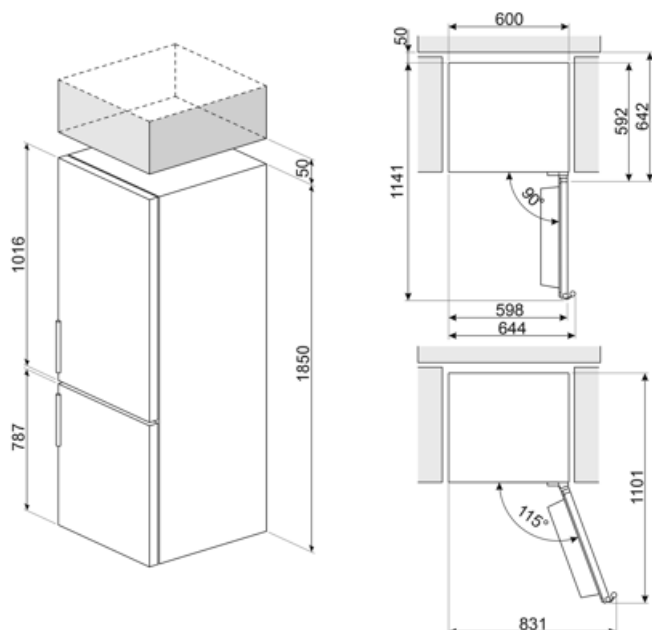

<b>Electrical connection rating</b>	70 W	<b>Frequency (Hz)</b>	50 Hz
<b>Current</b>	10 A	<b>Power supply cable length</b>	200 cm
<b>Voltage (V)</b>	220-240 V	<b>Plug</b>	(F;E) Schuko

## Logistic Information

<b>Width</b>	600 mm	<b>Height</b>	1850 mm
<b>Depth without handle</b>	592 mm		



## Symbols glossary

- |                                                                                   |                                                                                                                                                                    |                                                                                   |                                                                                                                                                                |
|-----------------------------------------------------------------------------------|--------------------------------------------------------------------------------------------------------------------------------------------------------------------|-----------------------------------------------------------------------------------|----------------------------------------------------------------------------------------------------------------------------------------------------------------|
|   | Compartimento de congelamento de 4 estrelas para uma melhor preservação dos alimentos.                                                                             |  | O sistema de descongelamento automático funciona descongelando automaticamente em intervalos regulares, eliminando a necessidade de descongelar completamente. |
|   | A++: A classe de eficiência energética A++ ajuda a economizar até 20% de energia em comparação com a classe A. O desempenho máximo com consumo mínimo é garantido. |  | Classe de eficiência energética E.                                                                                                                             |
|   | Display LED: para mostrar os programas, funções e opções selecionadas e o tempo até ao final do ciclo.                                                             |  | Modo económico: Analisa o funcionamento da geladeira durante a ativação e otimiza o ciclo de funcionamento, a fim de reduzir o consumo de energia.             |
|   | CONGELAMENTO RÁPIDO: A função de congelamento rápido reduz a temperatura do compartimento quando ativado algumas horas antes do uso.                               |  | Iluminação interior LED: é uma forma mais eficiente em termos energéticos e duradoura de iluminar o interior do aparelho.                                      |
|  | Ar mais: mantém a comida mais fresca por mais tempo.                                                                                                               |                                                                                   |                                                                                                                                                                |