

FC19XDNC



| | |
|----------------------------------|----------------|
| Product Family | Refrigerator |
| Installation | Free Standing |
| Category | Bottom Mount |
| Reference width | Until 60 |
| Cooling type | Total No Frost |
| Defrost | Automatic |
| Hinge type | Standard |
| Door opening flush with the wall | No |
| Slot-in | No |
| Reversible door | Yes |
| EAN code | 8017709323301 |



Aesthetics



| | | | |
|-------------------------------------|--------------|--|--------------------|
| Aesthetic | Universal | Logotipo | Logotipo aplicado |
| Colour | Aspecto inox | Cor do perfil das prateleiras da porta | Silver |
| Material | Steel Effect | Cor do perfil das gavetas | Silver |
| Handle kit to be ordered separately | No | Cor do perfil da prateleira de vidro | Chrome |
| Handle | Integrated | Display | LED |
| Handle type | Fixed | Mostrar porções | Externo (na porta) |
| Logo colour | Chrome | Dispenser | No |
| Side material | Steel | Water Filter | No |
| Side colour | Silver | HomeBar | No |

Refrigerator compartment features

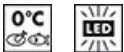

| | | | |
|---|------------------|---|-------|
| No. of adjustable shelves | 2 | Bottle shelf | Yes |
| Number of fruit and vegetables drawers | 1 | Type of crisper/vegetable drawers cover | Glass |
| Type of adjustable shelves | Glass | Life Plus zone-0°C | Yes |
| Type of crisper/vegetable drawers cover | On sliding rails | Internal light in fridge | Yes |
| Crisper Cover | Yes | Type of internal light (fridge) | LED |

Refrigerator Inner Door

| | | | |
|---|----|----------------------------------|----|
| Number of adjustable door shelves | 2 | No. of bottle shelves | 1 |
| Adjustable door shelves with wire support | No | Bottle shelves with wire support | No |

Other Refrigerator features



| | | | |
|------------------------|----------|-------------------------------|-----|
| Accessories | Egg tray | Ionizer | Yes |
| Natural Plus Blu Light | No | Tecnologia de titânio | No |
| MultiFlow | Yes | Filtro de odor antibacteriano | No |
| Fan | No | Zona de cuidados biológicos | No |

Freezer compartment features

| | | | |
|-------------------|---|---------------------------|----|
| Number of drawers | 3 | Internal light in freezer | No |
|-------------------|---|---------------------------|----|

Freezer Inner Door

| | |
|-----------|----|
| Pizza box | No |
|-----------|----|

Other Freezer features

| | | | |
|------------------|-----------|---------------------------|----|
| Accessories | 1 ice box | Fast freezing compartment | No |
| Manual ice maker | No | Ice tray shelf | No |
| Ice maker | No | | |

Other technical features

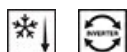

| | | | |
|--------------------------------|-------------------|---------------|--------------|
| Functions display | MultiZone | Fast freezing | Yes |
| Ligação à rede de água | Door open alarm | | No |
| Temperature Alarm | Temperature Alarm | | Yes |
| Type of temperature control | | | Yes |
| No. of compressors | | | Electronic |
| Refrigerant gas type | | | 1 |
| Type of compressor | | | R600a |
| Espuma expansiva de isolamento | | | Inverter |
| | | | Ciclopentano |

Etiqueta de Desempenho / Energia - Reg. 2019







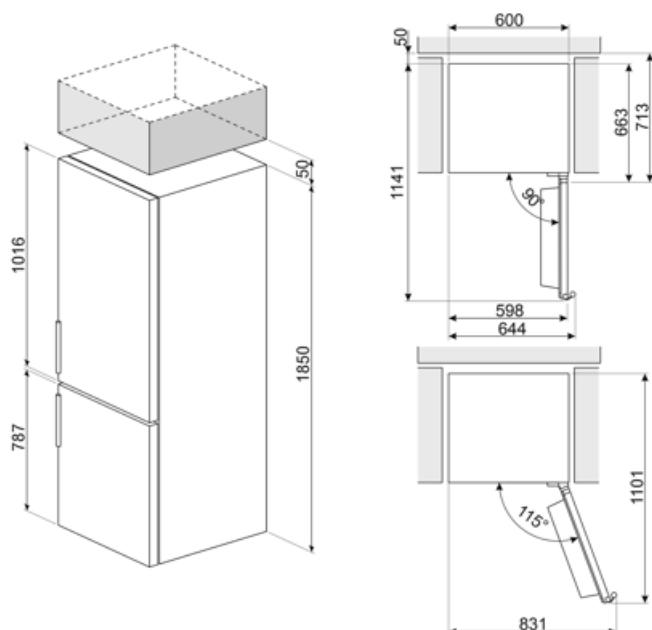

| | | | |
|--|-----------|---|------------------|
|  | | | |
| Consumo de energia anual | 165 kWh/a | Soma dos volumes do(s) refrigerado(s) e do(s) compartimento(s) não congelado(s) | 220 l |
| Classe de eficiência energética | C | Airborne acoustical noise emissions | 35 dB(A) re 1 pW |
| Classe de emissão de ruído acústico aerotransportado | C | Autonomia de conservação sem energia elétrica | 9 h |
| Volume líquido total | 326 l | Classe climática | SN, N, ST, T |
| Soma dos volumes do(s) compartimento(s) congelado(s) | 106 l | EI | 64 % |

Electrical Connection

| | | | |
|------------------------------|--------------|---------------------------|-----------|
| Plug | (F;E) Schuko | Voltage (V) | 220-240 V |
| Electrical connection rating | 110 W | Frequency (Hz) | 50 Hz |
| Current | 10 A | Power supply cable length | 200 cm |



Symbols glossary

| | | | |
|--|---|---|--|
|  | Smeg Active Ion system improves the quality of the air inside the cell. Thanks to the generation of negatively charged ions released inside the fridge Active Ion system neutralizes unpleasant dust. |  | O sistema de descongelamento automático funciona descongelando automaticamente em intervalos regulares, eliminando a necessidade de descongelar completamente. |
|  | Display LED: para mostrar os programas, funções e opções selecionadas e o tempo até ao final do ciclo. |  | CONGELAMENTO RÁPIDO: A função de congelamento rápido reduz a temperatura do compartimento quando ativado algumas horas antes do uso. |
|  | Iluminação interior LED: é uma forma mais eficiente em termos energéticos e duradoura de iluminar o interior do aparelho. |  | Life Plus 0°C: A temperatura nos compartimentos Lifeplus é mantida a 0°C, o que preserva a carne fresca e o peixe por mais tempo. |
|  | Tecnologia do inversor: A evolução dos secadores Smeg para modelos mais inteligentes e ambientalmente sustentáveis levou à escolha do uso da tecnologia do inversor com bombas de calor, o que reduz significativamente o consumo de energia. |  | Ar mais: mantém a comida mais fresca por mais tempo. |
|  | Classe de eficiência energética C | | |

Benefit (TT)

No-Frost system

The No Frost system prevents the formation of ice and contributes to better preservation of food in the refrigerator

Plastic multiflow system

The Multiflow system ensures even distribution of cold air inside the refrigerator

Multizone (variable temperature compartment)

The Multizone system isolates a freezer compartment with adjustable temperature independent of the main compartment, to give maximum storage flexibility

The Multizone compartment can be used both as a freezer and as a refrigerator. Depending on one's needs and eating habits, each user can choose how to set it, programming the temperature via the external display.

Refrigerant gas R600a

Environmentally friendly R600a refrigerant gas contributes to rapid cooling with lower energy consumption

Reversible door

Reversible door ensures flexible installation and space optimisation

Life Plus 0°

Temperature-controlled Life Plus compartment for optimal storage of specific food categories

Refrigerator Internal lighting

Interior lighting for perfect visibility of shelves in the refrigerator compartment

Fruit and vegetable drawer

The fruit and vegetable drawer ensures the best storage conditions for fresh food, avoiding any contamination

Inverter compressor

Inverter compressor reduces noise and vibration levels for a quiet and comfortable kitchen environment

Inverter compressor technology offers significant advantages for refrigeration systems, improving both performance and efficiency. Better temperature control ensures a more stable and constant indoor environment, preserving the freshness of food. This technology also results in reduced energy consumption, as the compressor adjusts its speed according to cooling needs.

External display

External display for simple and intuitive control with quick access to information