

## FC20EN1X



Product Family	Refrigerator
Installation	Free Standing
Category	Bottom Mount
Reference width	Until 60
Sistema Total No - Frost	Total
Cooling type	Total sem geadas - Sistema de arrefecimento duplo
Defrost	Automatic
Hinge type	Standard
Door opening flush with the wall	Yes
Slot-in	Yes
Hinge position	Right
Reversible door	Yes
EAN code	8017709295783



## Aesthetics



Aesthetic	Universal	Side material	Steel
Colour	Stainless steel	Side colour	Silver
Acabamento	Anti-dedadas	Logotipo	Logotipo aplicado
Design	Flat	Display	LCD
Material	Stainless steel	Mostrar porções	Interno (cela frigo)
Door steel type	Finger proof	Dispenser	No
Handle kit to be ordered separately	No	Water Filter	No
Handle	Integrated	HomeBar	No
Logo colour	Silver	Alternative colours available	White, Effetto Marmo

## Refrigerator compartment features



No. of adjustable shelves	2	Bottle shelf	No
Number of fruit and vegetables drawers	1	Type of crisper/vegetable drawers cover	Glass
Type of adjustable shelves	Glass	Life Plus zone-0°C	Yes
Type of crisper/vegetable drawers cover	On sliding rails	Internal light in fridge	Yes
Crisper Cover	Yes	Type of internal light (fridge)	LED

## Refrigerator Inner Door

**Number of adjustable door shelves** 2

**Adjustable door shelves with wire support** No

**No. of bottle shelves** 1

**Bottle shelves with wire support** No

## Other Refrigerator features



**Accessories** Egg tray

**Natural Plus Blu Light** No

**MultiFlow** Yes

**Fan** Yes

**Ionizer** No

## Freezer compartment features

**Number of drawers** 3

**Internal light in freezer** No

## Freezer Inner Door

**Pizza box** No

## Other Freezer features

**Accessories** 2 ice boxes

**Manual ice maker** No

**Ice maker** No

**Fast freezing compartment** No

**Ice tray shelf** No

## Other technical features



**Functions display**

**MultiZone**

**Door open alarm**

**Temperature Alarm**

**Antibacterial Gasket**

**Type of temperature control**

**No. of compressors**

**Refrigerant gas type**

**Type of compressor**

**Refrigerant Quantity (gr)**

**Espuma expansiva de isolamento**

Fast cooling, ECO

No

Yes

Yes

No

Electronic

1

R600a

Standard

50 g

Ciclopentano

## Etiqueta de Desempenho / Energia - Reg. 2019









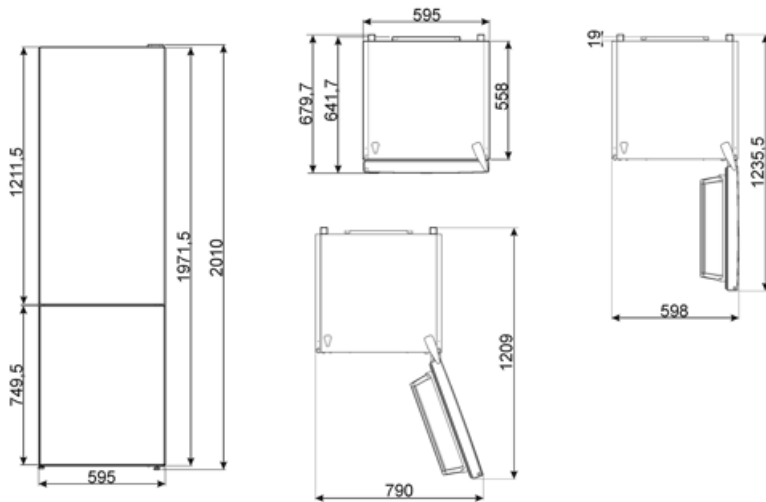





Consumo de energia anual	250 kWh/a	Airborne acoustical noise emissions	41 dB(A) re 1 pW
Classe de eficiência energética	E	Autonomia de conservação sem energia elétrica	11.32 h
Classe de emissão de ruído acústico aerotransportado	C	4 estrelas - Capacidade de congelamento	8.0 Kg/24h
Volume líquido total	366 l	Classe climática	SN, T
Soma dos volumes do(s) compartimento(s) congelado(s)	101 l	EI	100 %
Soma dos volumes do(s) compartimento(s) refrigerado(s) e do(s) compartimento(s) não congelado(s)	266 l		

## Electrical Connection

Plug	(F;E) Schuko	Voltage (V)	220-240 V
Electrical connection rating	180 W	Frequency (Hz)	50 Hz
Current	1,1 A	Power supply cable length	210 cm



## Symbols glossary

	Compartimento de congelamento de 4 estrelas para uma melhor preservação dos alimentos.		O sistema de descongelamento automático funciona descongelando automaticamente em intervalos regulares, eliminando a necessidade de descongelar completamente.
	A++: A classe de eficiência energética A++ ajuda a economizar até 20% de energia em comparação com a classe A. O desempenho máximo com consumo mínimo é garantido.		Classe de eficiência energética E.
	Display LCD: para otimizar o desempenho e simplificar o uso do aparelho.		Modo económico: Analisa o funcionamento da geladeira durante a ativação e otimiza o ciclo de funcionamento, a fim de reduzir o consumo de energia.
	Ventilado: Distribuição forçada de ar frio no compartimento da geladeira, o que permite uma distribuição uniforme da temperatura dentro da geladeira.		Aço inoxidável à prova de dedadas: O aço inoxidável à prova de dedadas mantém o aço inoxidável com um aspeto novo.
	Iluminação interior LED: é uma forma mais eficiente em termos energéticos e duradoura de iluminar o interior do aparelho.		Life Plus 0°C: A temperatura nos compartimentos Lifeplus é mantida a 0°C, o que preserva a carne fresca e o peixe por mais tempo.
	Ar mais: mantém a comida mais fresca por mais tempo.		Slot-in: As geladeiras com abertura Slot-in podem ser perfeitamente integrados na estrutura do mobiliário, uma vez que as portas abertas a 90° não vão além do lado do produto. Em caso de instalação ao lado da parede, será necessário considerar as dimensões do puxador para abrir a porta a 90°.

## Benefit (TT)

---

### **No-Frost system**

The No Frost system prevents the formation of ice and contributes to better preservation of food in the refrigerator

### **Plastic multiflow system**

The Multiflow system ensures even distribution of cold air inside the refrigerator

### **Fan**

The fan contributes to an even distribution of air inside the refrigerator

### **Refrigerant gas R600a**

Environmentally friendly R600a refrigerant gas contributes to rapid cooling with lower energy consumption

### **Climate class**

Climatic class SN-T makes the appliance suitable for working at room temperature between 10 °C and 43 °C (50 °F ~ 109 °F)

### **Reversible door**

Reversible door ensures flexible installation and space optimisation

### **Life Plus 0°**

Temperature-controlled Life Plus compartment for optimal storage of specific food categories

### **Refrigerator Internal lighting**

Interior lighting for perfect visibility of shelves in the refrigerator compartment

### **Fruit and vegetable drawer**

The fruit and vegetable drawer ensures the best storage conditions for fresh food, avoiding any contamination

### **Internal display**

Internal display for targeted temperature control and a clean, minimalist design