

FC20EN4AM



Product Family	Refrigerator
Installation	Free Standing
Category	Bottom Mount
Reference width	Until 60
Sistema Total No - Frost	Total
Cooling type	Total sem geadas - Sistema de arrefecimento duplo
Defrost	Automatic
Hinge type	Standard
Door opening flush with the wall	Yes
Slot-in	Yes
Hinge position	Right
Reversible door	Yes
EAN code	8017709295851



Aesthetics



Aesthetic	Universal	Side colour	Cream
Colour	Marble look	Logotipo	Logotipo aplicado
Design	Flat	Display	LCD Touch
Material	Metal sheet	Mostrar porções	Externo (na porta)
Handle kit to be ordered separately	No	Dispenser	No
Handle	Integrated	Water Filter	No
Logo colour	Silver	HomeBar	No
Side material	Steel	Alternative colours available	Stainless steel

Refrigerator compartment features

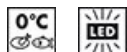

No. of adjustable shelves	2	Bottle shelf	No
Number of fruit and vegetables drawers	1	Type of crisper/vegetable drawers cover	Glass
Type of adjustable shelves	Glass	Life Plus zone-0°C	Yes
Type of crisper/vegetable drawers cover	On sliding rails	Internal light in fridge	Yes
Crisper Cover	Yes	Type of internal light (fridge)	LED

Refrigerator Inner Door

Number of adjustable door shelves	2	No. of bottle shelves	1
Adjustable door shelves with wire support	No	Bottle shelves with wire support	No

Other Refrigerator features



Accessories	Egg tray	Fan	Yes
Natural Plus Blu Light	No	Ionizer	Yes
MultiFlow	Yes		

Freezer compartment features

Number of drawers	3	Internal light in freezer	No
--------------------------	---	----------------------------------	----

Freezer Inner Door

Pizza box	No
------------------	----

Other Freezer features

Accessories	2 ice boxes	Fast freezing compartment	No
Manual ice maker	No	Ice tray shelf	No
Ice maker	No		

Other technical features



Functions display	Holiday, Fast freezing, Fast cooling, ECO, Control lock
MultiZone	No
Door open alarm	Yes
Temperature Alarm	Yes
Antibacterial Gasket	No
Type of temperature control	Electronic
No. of compressors	1
Refrigerant gas type	R600a
Type of compressor	Standard
Refrigerant Quantity (gr)	50 g
Espuma expansiva de isolamento	Ciclopentano

Etiqueta de Desempenho / Energia - Reg. 2019

			
Consumo de energia anual	250 kWh/a	Airborne acoustical noise emissions	41 dB(A) re 1 pW







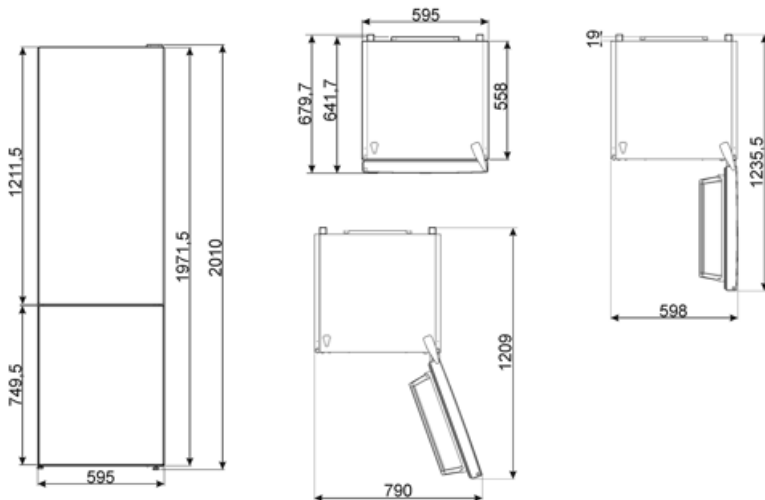







Classe de eficiência energética	E	Autonomia de conservação sem energia elétrica	11.32 h
Classe de emissão de ruído acústico aerotransportado	C	4 estrelas - Capacidade de congelamento	8.0 Kg/24h
Volume líquido total	366 l	Classe climática	SN, T
Soma dos volumes do(s) compartimento(s) congelado(s)	101 l	EEl	100 %
Soma dos volumes do(s) compartimento(s) refrigerado(s) e do(s) compartimento(s) não congelado(s)	266 l		

Electrical Connection

Plug	(F;E) Schuko	Voltage (V)	220-240 V
Electrical connection rating	180 W	Frequency (Hz)	50 Hz
Current	1,1 A	Power supply cable length	210 cm



Symbols glossary

-  Compartimento de congelamento de 4 estrelas para uma melhor preservação dos alimentos.
-  O sistema de descongelamento automático funciona descongelando automaticamente em intervalos regulares, eliminando a necessidade de descongelar completamente.
-  A++: A classe de eficiência energética A++ ajuda a economizar até 20% de energia em comparação com a classe A. O desempenho máximo com consumo mínimo é garantido.
-  Display LCD: para otimizar o desempenho e simplificar o uso do aparelho.
-  Ventilado: Distribuição forçada de ar frio no compartimento da geladeira, o que permite uma distribuição uniforme da temperatura dentro da geladeira.
-  Modo de economia de energia: O modo de economia de energia permite-lhe desativar a geladeira e manter o congelador a funcionar.
-  Life Plus 0°C: A temperatura nos compartimentos Lifeplus é mantida a 0°C, o que preserva a carne fresca e o peixe por mais tempo.
-  Slot-in: As geladeiras com abertura Slot-in podem ser perfeitamente integrados na estrutura do mobiliário, uma vez que as portas abertas a 90° não vão além do lado do produto. Em caso de instalação ao lado da parede, será necessário considerar as dimensões do puxador para abrir a porta a 90°.
-  Smeg Active Ion system improves the quality of the air inside the cell. Thanks to the generation of negatively charged ions released inside the fridge Active Ion system neutralizes unpleasant dust.
-  Bloqueio para crianças: alguns modelos estão equipados com um dispositivo para bloquear o programa/ciclo para que não possa ser acidentalmente alterado.
-  Classe de eficiência energética E.
-  Modo económico: Analisa o funcionamento da geladeira durante a ativação e otimiza o ciclo de funcionamento, a fim de reduzir o consumo de energia.
-  CONGELAMENTO RÁPIDO: A função de congelamento rápido reduz a temperatura do compartimento quando ativado algumas horas antes do uso.
-  Iluminação interior LED: é uma forma mais eficiente em termos energéticos e duradoura de iluminar o interior do aparelho.
-  Ar mais: mantém a comida mais fresca por mais tempo.

Benefit (TT)

No-Frost system

The No Frost system prevents the formation of ice and contributes to better preservation of food in the refrigerator

Plastic multiflow system

The Multiflow system ensures even distribution of cold air inside the refrigerator

Fan

The fan contributes to an even distribution of air inside the refrigerator

Refrigerant gas R600a

Environmentally friendly R600a refrigerant gas contributes to rapid cooling with lower energy consumption

Climate class

Climatic class SN-T makes the appliance suitable for working at room temperature between 10 °C and 43 °C (50 °F ~ 109 °F)

Reversible door

Reversible door ensures flexible installation and space optimisation

Life Plus 0°

Temperature-controlled Life Plus compartment for optimal storage of specific food categories

Refrigerator Internal lighting

Interior lighting for perfect visibility of shelves in the refrigerator compartment

Fruit and vegetable drawer

The fruit and vegetable drawer ensures the best storage conditions for fresh food, avoiding any contamination

External display

External display for simple and intuitive control with quick access to information