

FC20UXDNE



Product Family	Refrigerator
Installation	Free standing
Category	Bottom Mount
Sistema Total No - Frost	Yes
Cooling type	Total No Frost
Defrost	Automatic
Hinge type	Standard
Slot-in	Yes
Kitchen panel	Not supplied
Hinge position	Right
Reversible door	Yes
EAN code	8017709312992



Aesthetics



Aesthetic	Universale	Side colour	Silver
Colour	Stainless steel	Logo	Applied
Finishing	Fingerproof	Door shelves profile color	White
Material	Steel Effect	Color of glass shelf profile	Silver
Door steel type	Finger proof	Display	LED
Handle	External	Display position	Esterno (su porta)
Side material	Steel		

Refrigerator compartment features



Number of compartments	2	Type of crisper/vegetable drawers cover	On sliding rails
Compartment types	Low temperature compartment, Fruit and vegetable compartment	Bottle shelf	Yes
No. of adjustable shelves	3	Low temperature compartment	Yes
Number of fruit and vegetables drawers	1	Type of internal light (fridge)	LED
Shelves material	Glass		

Refrigerator Inner Door

No. of bottle shelves	1
-----------------------	---

Number of adjustable door shelves 3

Other Refrigerator features



Humidity Control Accessories

Yes
Egg tray

MultiFlow

Yes

Freezer compartment features

Number of drawers 3

Other technical features



Functions display

Fast freezing, ECO

Temperature alarm lamp

Yes

Door open alarm

Yes

Type of temperature control

Electronic

No. of compressors

1

Refrigerant gas type

R600a

Type of compressor

Standard

No. of evaporators

1

Refrigerant Quantity (gr)

1.1 oz

Foam agent

Cyclopentane

Performance / Energy Label - Reg. 2019

Total gross volume 12.5 cu. ft.

Airborne acoustical noise emissions 38 dB(A) re 1 pW

Gross volume frozen food compartment 4.2 cu. ft.

Fresh Food compartment - Gross Volume 8.3 cu. ft.

Electrical Connection

Current 10 A

Voltage (V) 120 V

Frequency (Hz) 60 Hz

Power supply cable length 74 13/16 "

Plug (B) NEMA 5-15P

Logistic Information

Width 23 5/8 "

Depth without handle 23 5/16 "







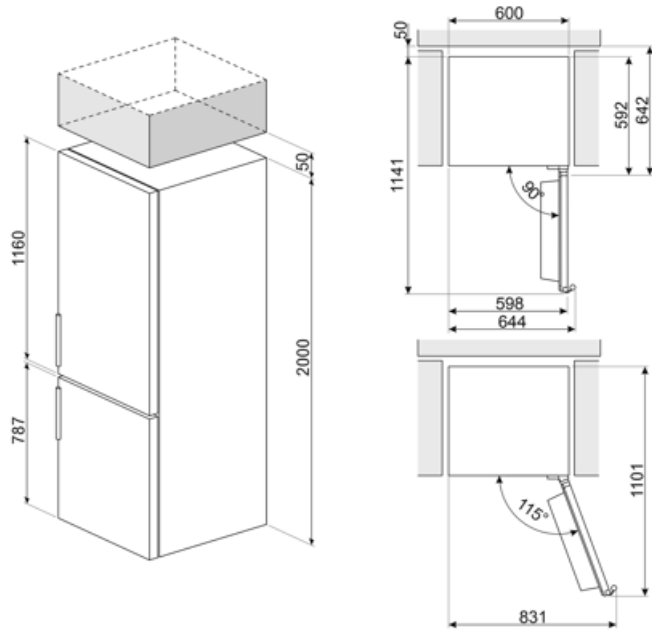

Height 78 3/4 "

Product depth with
handle

25 1/16 "



Symbols glossary

	4 stars freezing compartment for better food preservation.		The automatic defrost system works by automatically defrosting at regular intervals eliminating the need to defrost altogether.
	LED display: to show programmes, functions and options selected and the time to the end of the cycle.		Economical mode: Analyzes fridge functioning during the activation and optimizes the operating cycle in order to reduce power consumption.
	Fast freezing: The fast freezing function brings the temperature of the compartment down when activated a few hours prior to usage.		Fingerprint proof stainless steel: Fingerprint proof stainless steel keeps stainless steel looking as good as new.
	LED interior lighting: is a more energy efficient and long lasting way of illuminating the interior of the appliance.		Air plus: keeps food fresher for longer.
	Slot-in: The refrigerators with Slot-in opening can be perfectly integrated into the furniture structure, as the doors open at 90° do not go beyond the side of the product. In case of installation next to the wall, it will be necessary to consider the dimensions of the handle in order to open the door at 90°.		