

# FC21DNEX



<b>Product Family</b>	Refrigerator
<b>Installation</b>	Free Standing
<b>Category</b>	Bottom Mount
<b>Reference width</b>	Until 60
<b>Sistema Total No - Frost</b>	Total
<b>Cooling type</b>	Total sem geada - Sistema de arrefecimento duplo
<b>Defrost</b>	Automatic
<b>Hinge type</b>	Standard
<b>Door opening flush with the wall</b>	Yes
<b>Slot-in</b>	No
<b>Hinge position</b>	Right
<b>Reversible door</b>	Yes
<b>EAN code</b>	8017709295899



## Aesthetics



<b>Aesthetic</b>	Universal	<b>Side colour</b>	Silver
<b>Colour</b>	Stainless steel	<b>Logotipo</b>	Logotipo aplicado
<b>Acabamento</b>	Anti-dedadas	<b>Cor do perfil das prateleiras da porta</b>	Silver
<b>Design</b>	Flat	<b>Cor do perfil das gavetas</b>	Silver
<b>Material</b>	Stainless steel	<b>Cor do perfil da prateleira de vidro</b>	Silver
<b>Door steel type</b>	Finger proof	<b>Display</b>	LCD Touch
<b>Handle kit to be ordered separately</b>	No	<b>Mostrar porções</b>	Externo (na porta)
<b>Handle</b>	Integrated	<b>Dispenser</b>	No
<b>Logo colour</b>	Chrome	<b>Water Filter</b>	No
<b>Side material</b>	Steel	<b>HomeBar</b>	No

## Refrigerator compartment features



<b>No. of adjustable shelves</b>	2	<b>Type of crisper/vegetable drawers cover</b>	Glass
<b>Number of fruit and vegetables drawers</b>	1	<b>Life Plus zone-0°C</b>	Yes
<b>Type of adjustable shelves</b>	Glass	<b>Compartimento baixa temperatura</b>	No
<b>Type of crisper/vegetable drawers cover</b>	On sliding rails	<b>Internal light in fridge</b>	Yes
		<b>Type of internal light (fridge)</b>	LED

Crisper Cover	Yes
Bottle shelf	No

## Refrigerator Inner Door

Number of adjustable door shelves	2	No. of bottle shelves	1
Adjustable door shelves with wire support	No	Bottle shelves with wire support	No

## Other Refrigerator features



Accessories	Egg tray	Fan	Yes
Natural Plus Blu Light	No	Ionizer	Yes
MultiFlow	Yes		

## Freezer compartment features

Number of drawers	3	Internal light in freezer	No
-------------------	---	---------------------------	----

## Freezer Inner Door

Pizza box	No
-----------	----

## Other Freezer features

Accessories	2 ice boxes	Fast freezing compartment	No
Manual ice maker	No	Ice tray shelf	No
Ice maker	No		

## Other technical features



Functions display	Holiday, Fast freezing, Fast cooling, ECO, Control lock
MultiZone	No
Ligação à rede de água	No
Door open alarm	Yes
Temperature Alarm	Yes
Antibacterial Gasket	No
Type of temperature control	Electronic
No. of compressors	1
Refrigerant gas type	R600a
Type of compressor	Inverter
Refrigerant Quantity (gr)	65 g

## Etiqueta de Desempenho / Energia - Reg. 2019





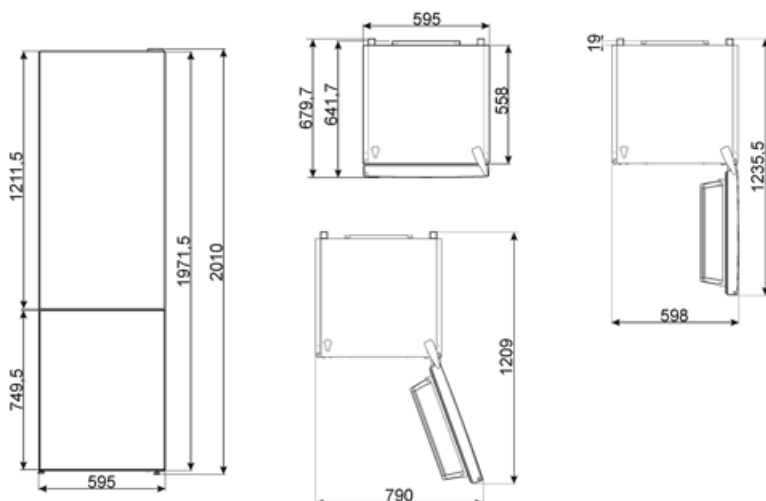

			
Consumo de energia anual	200 kWh/a	Airborne acoustical noise emissions	39 dB(A) re 1 pW
Classe de eficiência energética	D	Autonomia de conservação sem energia elétrica	11.47 h
Classe de emissão de ruído acústico aerotransportado	C	4 estrelas - Capacidade de congelamento	8.0 Kg/24h
Volume líquido total	366 l	Classe climática	SN, T
Soma dos volumes do(s) compartimento(s) congelado(s)	101 l	EEl	80 %
Soma dos volumes do(s) compartimento(s) refrigerado(s) e do(s) compartimento(s) não congelado(s)	266 l		

## Electrical Connection

Plug	(F;E) Schuko	Voltage (V)	220-240 V
Electrical connection rating	180 W	Frequency (Hz)	50 Hz
Current	1.1 A	Power supply cable length	210 cm



## Symbols glossary

	Compartimento de congelamento de 4 estrelas para uma melhor preservação dos alimentos.		A+++ : Os aparelhos com este símbolo podem reduzir o consumo de energia em mais 30% em relação à classificação de energia padrão A.
	Smeg Active Ion system improves the quality of the air inside the cell. Thanks to the generation of negatively charged ions released inside the fridge Active Ion system neutralizes unpleasant dust.		O sistema de descongelamento automático funciona descongelando automaticamente em intervalos regulares, eliminando a necessidade de descongelar completamente.
	Bloqueio para crianças: alguns modelos estão equipados com um dispositivo para bloquear o programa/ciclo para que não possa ser acidentalmente alterado.		Display LCD: para otimizar o desempenho e simplificar o uso do aparelho.
	Modo económico: Analisa o funcionamento da geladeira durante a ativação e otimiza o ciclo de funcionamento, a fim de reduzir o consumo de energia.		Ventilado: Distribuição forçada de ar frio no compartimento da geladeira, o que permite uma distribuição uniforme da temperatura dentro da geladeira.
	CONGELAMENTO RÁPIDO: A função de congelamento rápido reduz a temperatura do compartimento quando ativado algumas horas antes do uso.		Aço inoxidável à prova de dedadas: O aço inoxidável à prova de dedadas mantém o aço inoxidável com um aspeto novo.
	Modo de economia de energia: O modo de economia de energia permite-lhe desativar a geladeira e manter o congelador a funcionar.		Iluminação interior LED: é uma forma mais eficiente em termos energéticos e duradoura de iluminar o interior do aparelho.
	Life Plus 0°C: A temperatura nos compartimentos Lifeplus é mantida a 0°C, o que preserva a carne fresca e o peixe por mais tempo.		Tecnologia do inversor: A evolução dos secadores Smeg para modelos mais inteligentes e ambientalmente sustentáveis levou à escolha do uso da tecnologia do inversor com bombas de calor, o que reduz significativamente o consumo de energia.
	Ar mais: mantém a comida mais fresca por mais tempo.		Classe de eficiência energética D

## Benefit (TT)

---

### **No-Frost system**

The No Frost system prevents the formation of ice and contributes to better preservation of food in the refrigerator

### **Plastic multiflow system**

The Multiflow system ensures even distribution of cold air inside the refrigerator

### **Fan**

The fan contributes to an even distribution of air inside the refrigerator

### **Refrigerant gas R600a**

Environmentally friendly R600a refrigerant gas contributes to rapid cooling with lower energy consumption

### **Climate class**

Climatic class SN-T makes the appliance suitable for working at room temperature between 10 °C and 43 °C (50 °F ~ 109 °F)

### **Reversible door**

Reversible door ensures flexible installation and space optimisation

### **Life Plus 0°**

Temperature-controlled Life Plus compartment for optimal storage of specific food categories

### **Refrigerator Internal lighting**

Interior lighting for perfect visibility of shelves in the refrigerator compartment

### **Fruit and vegetable drawer**

The fruit and vegetable drawer ensures the best storage conditions for fresh food, avoiding any contamination

### **Inverter compressor**

Inverter compressor reduces noise and vibration levels for a quiet and comfortable kitchen environment

Inverter compressor technology offers significant advantages for refrigeration systems, improving both performance and efficiency. Better temperature control ensures a more stable and constant indoor environment, preserving the freshness of food. This technology also results in reduced energy consumption, as the compressor adjusts its speed according to cooling needs.

### **External display**

External display for simple and intuitive control with quick access to information