

FC21XDND



Product Family	Refrigerator
Installation	Free Standing
Category	Bottom Mount
Reference width	Until 60
Cooling type	Total No Frost
Defrost	Automatic
Hinge type	Standard
Door opening flush with the wall	No
Slot-in	No
Hinge position	Right
Reversible door	Yes
EAN code	8017709309602



Aesthetics



Aesthetic	Universal	Logotipo	Logotipo aplicado
Colour	Aspecto inox	Cor do perfil das prateleiras da porta	Silver
Material	Steel Effect	Cor do perfil das gavetas	Silver
Handle kit to be ordered separately	No	Cor do perfil da prateleira de vidro	Chrome
Handle	Integrated	Display	LED
Handle type	Fixed	Mostrar porções	Externo (na porta)
Logo colour	Chrome	Dispenser	No
Side material	Steel	Water Filter	No
Side colour	Silver	HomeBar	No

Refrigerator compartment features

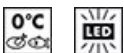

No. of adjustable shelves	3	Bottle shelf	Yes
Number of fruit and vegetables drawers	1	Type of crisper/vegetable drawers cover	Glass
Type of adjustable shelves	Glass	Life Plus zone-0°C	Yes
Type of crisper/vegetable drawers cover	On sliding rails	Internal light in fridge	Yes
Crisper Cover	Yes	Type of internal light (fridge)	LED

Refrigerator Inner Door

Number of adjustable door shelves	3	No. of bottle shelves	1
Adjustable door shelves with wire support	No	Bottle shelves with wire support	No

Other Refrigerator features



Accessories	Cheese box, Egg tray	Ionizer	Yes
Natural Plus Blu Light	No	Tecnologia de titânio	No
MultiFlow	Yes	Filtro de odor antibacteriano	No
Fan	No	Zona de cuidados biológicos	No

Freezer compartment features

Number of drawers	3	Internal light in freezer	No
-------------------	---	---------------------------	----

Freezer Inner Door

Pizza box	No
-----------	----

Other Freezer features

Accessories	1 ice box	Fast freezing compartment	No
Manual ice maker	No	Ice tray shelf	No
Ice maker	No		

Other technical features



Functions display	MultiZone	Fast freezing	Yes
Ligação à rede de água	Temperature Alarm		No
Type of temperature control	No. of compressors		Yes
Refrigerant gas type	Type of compressor		Electronic
Type of compressor	Espuma expansiva de isolamento		1
			R600a
			Inverter
			Ciclopentano

Etiqueta de Desempenho / Energia - Reg. 2019







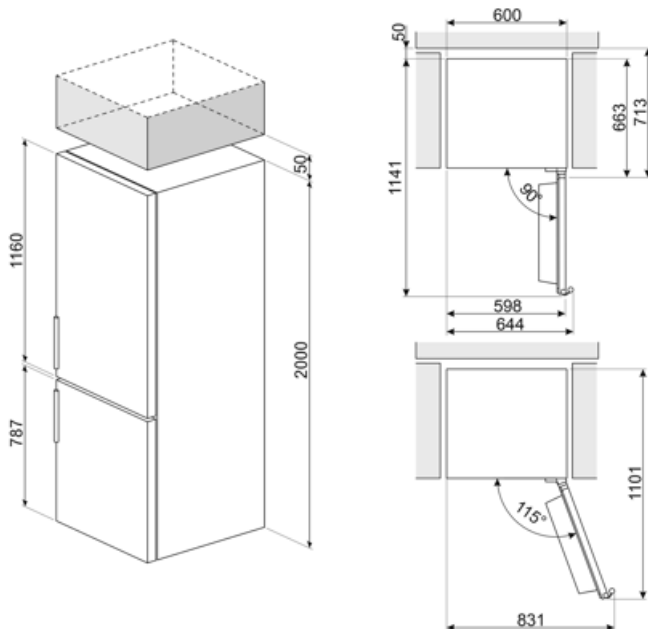

D			
Consumo de energia anual	211 kWh/a	Airborne acoustical noise emissions	37 dB(A) re 1 pW
Classe de eficiência energética	D	Autonomia de conservação sem energia elétrica	9 h
Classe de emissão de ruído acústico aerotransportado	C	4 estrelas - Capacidade de congelamento	11.0 Kg/24h
Volume líquido total	361 l	Classe climática	SN, N, ST, T
Soma dos volumes do(s) compartimento(s) congelado(s)	106 l	EEl	80 %
Soma dos volumes do(s) compartimento(s) refrigerado(s) e do(s) compartimento(s) não congelado(s)	255 l		

Electrical Connection

Plug	(F;E) Schuko	Voltage (V)	220-240 V
Electrical connection rating	110 W	Frequency (Hz)	50 Hz
Current	10 A	Power supply cable length	200 cm



Symbols glossary

	Smeg Active Ion system improves the quality of the air inside the cell. Thanks to the generation of negatively charged ions released inside the fridge Active Ion system neutralizes unpleasant dust.		O sistema de descongelamento automático funciona descongelando automaticamente em intervalos regulares, eliminando a necessidade de descongelar completamente.
	Display LED: para mostrar os programas, funções e opções selecionadas e o tempo até ao final do ciclo.		CONGELAMENTO RÁPIDO: A função de congelamento rápido reduz a temperatura do compartimento quando ativado algumas horas antes do uso.
	Iluminação interior LED: é uma forma mais eficiente em termos energéticos e duradoura de iluminar o interior do aparelho.		Life Plus 0°C: A temperatura nos compartimentos Lifeplus é mantida a 0°C, o que preserva a carne fresca e o peixe por mais tempo.
	Tecnologia do inversor: A evolução dos secadores Smeg para modelos mais inteligentes e ambientalmente sustentáveis levou à escolha do uso da tecnologia do inversor com bombas de calor, o que reduz significativamente o consumo de energia.		Ar mais: mantém a comida mais fresca por mais tempo.
	Classe de eficiência energética D		

Benefit (TT)

No-Frost system

The No Frost system prevents the formation of ice and contributes to better preservation of food in the refrigerator

Plastic multiflow system

The Multiflow system ensures even distribution of cold air inside the refrigerator

Multizone (variable temperature compartment)

The Multizone system isolates a freezer compartment with adjustable temperature independent of the main compartment, to give maximum storage flexibility

The Multizone compartment can be used both as a freezer and as a refrigerator. Depending on one's needs and eating habits, each user can choose how to set it, programming the temperature via the external display.

Refrigerant gas R600a

Environmentally friendly R600a refrigerant gas contributes to rapid cooling with lower energy consumption

Reversible door

Reversible door ensures flexible installation and space optimisation

Life Plus 0°

Temperature-controlled Life Plus compartment for optimal storage of specific food categories

Refrigerator Internal lighting

Interior lighting for perfect visibility of shelves in the refrigerator compartment

Fruit and vegetable drawer

The fruit and vegetable drawer ensures the best storage conditions for fresh food, avoiding any contamination

Inverter compressor

Inverter compressor reduces noise and vibration levels for a quiet and comfortable kitchen environment

Inverter compressor technology offers significant advantages for refrigeration systems, improving both performance and efficiency. Better temperature control ensures a more stable and constant indoor environment, preserving the freshness of food. This technology also results in reduced energy consumption, as the compressor adjusts its speed according to cooling needs.

External display

External display for simple and intuitive control with quick access to information