

FC48KDND



Product Family	Refrigerator
Installation	Free Standing
Category	Bottom Mount
Reference width	60 - 70
Reference height	160 - 200
Sistema Total No - Frost	Yes
Cooling type	No Frost
Defrost	Automatic
Hinge type	Standard
Door opening flush with the wall	No
Slot-in	No
Hinge position	Right
Reversible door	Yes
EAN code	8017709343545



Aesthetics



Aesthetic	Universal	Logotipo	Logotipo serigrafado
Colour	Dark Inox Look	Cor do perfil das prateleiras da porta	Dark Inox Look
Material	Steel Effect	Cor do perfil das gavetas	Dark Inox Look
Door steel type	Normal	Cor do perfil da prateleira de vidro	Dark Inox Look
Handle kit to be ordered separately	No	Display	LED
Handle	Integrated	Mostrar porções	Externo (na porta)
Logo colour	Silver	Dispenser	No
Side material	Steel	Water Filter	No
Side colour	Glossy Black	HomeBar	No

Refrigerator compartment features



No. of adjustable shelves	3	Nº de lâmpadas	2
Number of fruit and vegetables drawers	1	Life Plus zone-0°C	No
Type of adjustable shelves	Glass	Convertible temperature drawer	No
Type of crisper/vegetable drawers cover	Standard	Compartimento baixa temperatura	Yes
Crisper Cover	Yes	Internal light in fridge	Yes
		Type of internal light (fridge)	LED

Bottle shelf	No
Type of crisper/vegetable drawers cover	Glass

Refrigerator Inner Door

Number of adjustable door shelves	3	No. of bottle shelves	1
Adjustable door shelves with wire support	No	Bottle shelves with wire support	No

Other Refrigerator features



Accessories	Egg tray	Ionizer	No
Natural Plus Blu Light	No	Tecnologia de titânio	No
MultiFlow	No	Filtro de odor antibacteriano	No
Fan	Yes	Zona de cuidados biológicos	No

Freezer compartment features

Number of drawers	2	Internal light in freezer	No
No. of compartments with flap	1	Type of shelves	Glass

Other Freezer features



Accessories	manual ice-maker	Ice maker	Manual
Manual ice maker	Yes	Fast freezing compartment	Yes

Other technical features



Functions display	Holiday, Fast freezing, Fast cooling, ECO, Control lock, Cooling timer
MultiZone	No
Fast freezing button	Yes
Ligação à rede de água	No
Power on lamp	Yes
Door open alarm	Yes
Type of temperature control	Electronic
No. of compressors	1

Refrigerant gas type	R600a
Type of compressor	Inverter
Refrigerant Quantity (gr)	68 g
Espuma expansiva de isolamento	Ciclopentano

Etiqueta de Desempenho / Energia - Reg. 2019







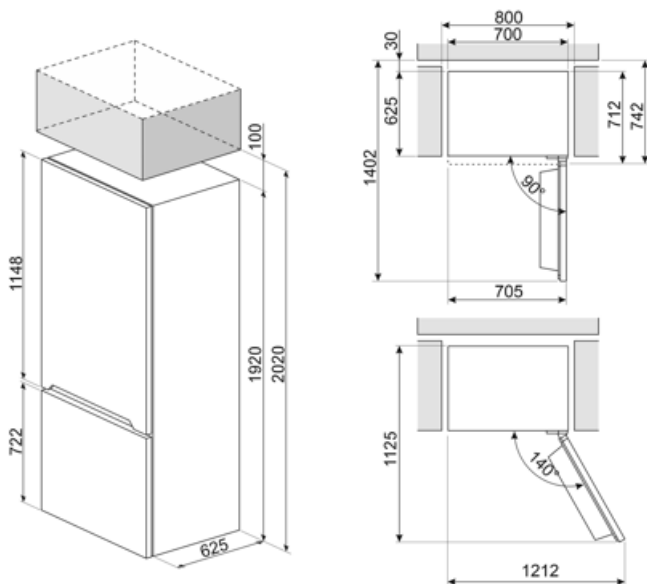



			
Consumo de energia anual	230 kWh/a	Airborne acoustical noise emissions	41 dB(A) re 1 pW
Classe de eficiência energética	D	Autonomia de conservação sem energia elétrica	14 h
Classe de emissão de ruído acústico aerotransportado	C	4 estrelas - Capacidade de congelamento	8.0 Kg/24h
Volume líquido total	481 l	Classe climática	SN, N, ST, T
Soma dos volumes do(s) compartimento(s) congelado(s)	137 l	EI	80 %
Soma dos volumes do(s) compartimento(s) refrigerado(s) e do(s) compartimento(s) não congelado(s)	344 l		

Electrical Connection

Plug	(F;E) Schuko	Voltage (V)	220-240 V
Electrical connection rating	185 W	Frequency (Hz)	50 Hz
Current	1,27 A	Power supply cable length	210 cm



Symbols glossary

-  O sistema de descongelamento automático funciona descongelando automaticamente em intervalos regulares, eliminando a necessidade de descongelar completamente.
-  Display LED: para mostrar os programas, funções e opções selecionadas e o tempo até ao final do ciclo.
-  Ventilado: Distribuição forçada de ar frio no compartimento da geladeira, o que permite uma distribuição uniforme da temperatura dentro da geladeira.
-  Modo de economia de energia: O modo de economia de energia permite-lhe desativar a geladeira e manter o congelador a funcionar.
-  Tecnologia do inversor: A evolução dos secadores Smeg para modelos mais inteligentes e ambientalmente sustentáveis levou à escolha do uso da tecnologia do inversor com bombas de calor, o que reduz significativamente o consumo de energia.
-  Classe de eficiência energética D
-  Bloqueio para crianças: alguns modelos estão equipados com um dispositivo para bloquear o programa/ciclo para que não possa ser acidentalmente alterado.
-  Modo económico: Analisa o funcionamento da geladeira durante a ativação e otimiza o ciclo de funcionamento, a fim de reduzir o consumo de energia.
-  CONGELAMENTO RÁPIDO: A função de congelamento rápido reduz a temperatura do compartimento quando ativado algumas horas antes do uso.
-  Iluminação interior LED: é uma forma mais eficiente em termos energéticos e duradoura de iluminar o interior do aparelho.
-  No Frost: Os sistemas sem geada e livre de geada impedem a formação de gelo, de modo que não é necessário descongelar.

Benefit (TT)

No-Frost system

The No Frost system prevents the formation of ice and contributes to better preservation of food in the refrigerator

Fan

The fan contributes to an even distribution of air inside the refrigerator

Refrigerant gas R600a

Environmentally friendly R600a refrigerant gas contributes to rapid cooling with lower energy consumption

Reversible door

Reversible door ensures flexible installation and space optimisation

Refrigerator Internal lighting

Interior lighting for perfect visibility of shelves in the refrigerator compartment

Fruit and vegetable drawer

The fruit and vegetable drawer ensures the best storage conditions for fresh food, avoiding any contamination

Inverter compressor

Inverter compressor reduces noise and vibration levels for a quiet and comfortable kitchen environment

Inverter compressor technology offers significant advantages for refrigeration systems, improving both performance and efficiency. Better temperature control ensures a more stable and constant indoor environment, preserving the freshness of food. This technology also results in reduced energy consumption, as the compressor adjusts its speed according to cooling needs.

Manual Ice Maker

Manual ice maker to manually adjust the amount of ice produced according to personal requirements

External display

External display for simple and intuitive control with quick access to information