

FC48XNE



Product familie	Koelkast
Installatie	Vrijstaand
Categorie	Koel-vriescombinatie
Referentie breedte	60 - 70 cm cm
Referentie hoogte	160 - 200 cm cm
No Frost systeem	Ja
Type koelen	No Frost
Ontdooien	Automatisch ontdooien
Type scharnier	Standaard
Positie scharnier	Rechts
Deur omkeerbaar	Ja
EAN-code	8017709343514



Design



Design	Universeel	Logo	Geëtst
Kleur	Inox Look	Kleur profielen binnenzijde	Zilver
Materiaal deur	Inox look	Kleur profielen laden	Zilver
Handgreep	Geïntegreerd	Kleur profiel glazen leggers	Zilver
Kleur logo	Zilver	Display	LCD
Materiaal zijwanden	Staal	Positie display	Interno (cella frigo)

Uitrusting koelkast



Number of compartments	2	Type afdekplaat groente-/fruitlade	Glas
Compartment types	Low temperature compartment, Fruit and vegetable compartment	Aantal lampen	2
Aantal verstelbare leggers	3	Convertible temperature drawer	No
Aantal groente-/fruitlades	1	Low temperature compartment	Ja
Shelves material	Glas	Binnenverlichting koelkast	Ja
Type afdekplaat groente-/fruitlade	Standaard	Type binnenverlichting koelkast	LED
Afdekplaat groentenlade	Ja		

Binnendeur koelkast

Aantal verstelbare binnendeurcompartimenten	3	Aantal flessenhouders	1
---	---	-----------------------	---

Overige features koelkast



Humidity Control	Yes, manual	Ventilator	Ja
Accessoires	Eierhouder		

Uitrusting vriezer

Aantal lades	2	Type leggers	Glas
Aantal compartimenten met klep	1		

Overige features vriezer



Accessoires	Ijsmaker (manueel)	Snel-vriescompartiment	Ja
Ice maker	Manueel ontdooien		

Overige technische eigenschappen



Display functies	Snel-vriesfunctie, ECO
Snel-vriestoets	Ja
Alarm open deur	Akoestisch
Type temperatuurcontrole	Elektronisch
Aantal compressoren	1
Type koelgas	R600a
Type compressor	Variabele toeren
Schuimmiddel	Cyclopentaan

Prestaties/Energie label - Reg. 2019



Annual energy consumption	287 kWh/jaar	Netto inhoud koelgedeeltes	344 l
Energie-efficiëntieklasse	E	Geluidsniveau	41 dB(A) re 1 pW
Emissieklasse voor akoestisch luchtgeluid	C	Conserveringsduur zonder stroom	14 h
Totaal netto volume	481 l		

Netto inhoud vriesgedeelte	137 l	Klimaatklasse EEI	SN, N, ST, T 100 %
----------------------------	-------	----------------------	-----------------------

Elektrische aansluiting







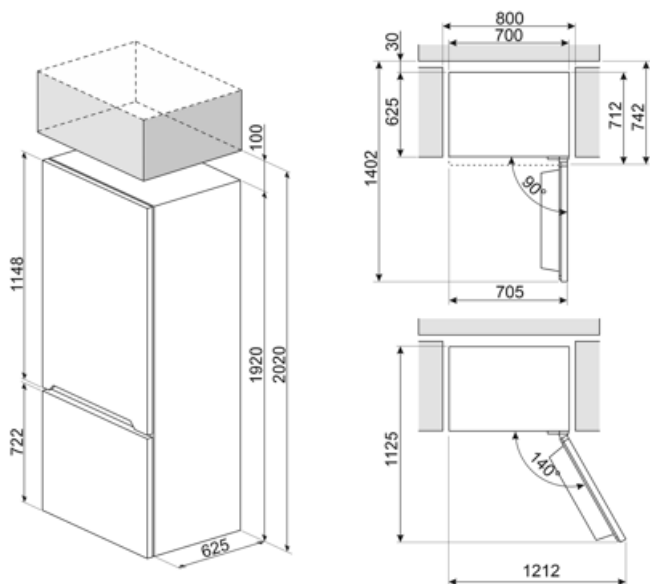

Nominale aansluitwaarde	185 W	Frequentie (Hz)	50 Hz
Stroom (A)	1,27 A	Lengte stroomkabel	210 cm
Spanning (V)	220-240 V	Stekker	(F;E) Schuko

Logistieke informatie

Breedte product (mm)	700 mm	Maximum hoogte	1920 mm
Diepte zonder handvat en spacer	712 mm	Diepte toestel met deuren open 90°	1390 mm



Symbols glossary

	The automatic defrost system works by automatically defrosting at regular intervals eliminating the need to defrost altogether.		Energie-efficiëntieklasse
	LCD display: to optimize performance and simplify the use of the appliance.		Economical mode: Analyzes fridge functioning during the activation and optimizes the operating cycle in order to reduce power consumption.
	Geventileerd: een geforceerde verdeling van koude lucht in het koelkast compartiment, die een gelijke temperatuurverdeling verzekert in de koelkast.		Fast freezing: The fast freezing function brings the temperature of the compartment down when activated a few hours prior to usage.
	LED interior lighting: is a more energy efficient and long lasting way of illuminating the interior of the appliance.		De evolutie van Smeg vaatwassers naar meer intelligente en milieuvriendelijke modellen heeft ertoe geleid om de inverter technologie te gebruiken, die een significante energie- en geluidsbesparing met zich meebrengt.