

## FD48PXNF4



Product Family	Refrigerator
Installation	Free standing
Category	Top Mount
Sistema Total No - Frost	Total
Cooling type	Total No Frost - Double Cooling system
Defrost	Automatic
Hinge type	Standard
Hinge position	Right
Reversible door	Yes
EAN code	8017709228477



## Aesthetics



Aesthetic	Universale	Handle colour	Silver
Colour	Stainless steel	Logo colour	Chrome
Design	Flat	Side material	Steel
Finishing	Fingerproof	Side colour	Silver
Material	Stainless steel	Logo	Applied
Door steel type	Finger proof	Display position	
Handle	External	Alternative colours available	Effetto Marmo
Handle type	Fixed	Available colours	FD481MN4

## Refrigerator compartment features

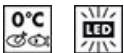

No. of adjustable shelves	3	Type of crisper/vegetable drawers cover	Glass
Number of fruit and vegetables drawers	2	Life Plus zone-0°C	Yes, with manual control
Shelves material	Glass	Internal light in fridge	Yes
Type of crisper/vegetable drawers cover	Standard	Type of internal light (fridge)	LED
Crisper Cover	Yes		

## Refrigerator Inner Door

---

Number of adjustable door shelves 3

No. of bottle shelves 1

---

## Other Refrigerator features



Accessories  
MultiFlow

Egg tray  
Yes

Ionizer

---

## Freezer compartment features

No. of shelves 1

No. of compartments with flap 1

Internal light in freezer Yes

Type of internal light (freezer) LED

Type of shelves Plastic

---

## Freezer Inner Door

No. of adjustable door shelves 2

---

## Other Freezer features



Ice maker

Manual

Fast freezing compartment

Yes

---

## Other technical features

Water network connection

Type of temperature control

No. of compressors

Refrigerant gas type

Type of compressor

Refrigerant Quantity (g)

Foam agent

Electro-mechanical

1

R600a

Standard

62 g

Cyclopentane

---

## Performance / Energy Label - Reg. 2019

Airborne acoustical noise emissions 43 dB(A) re 1 pW

---

## Electrical Connection







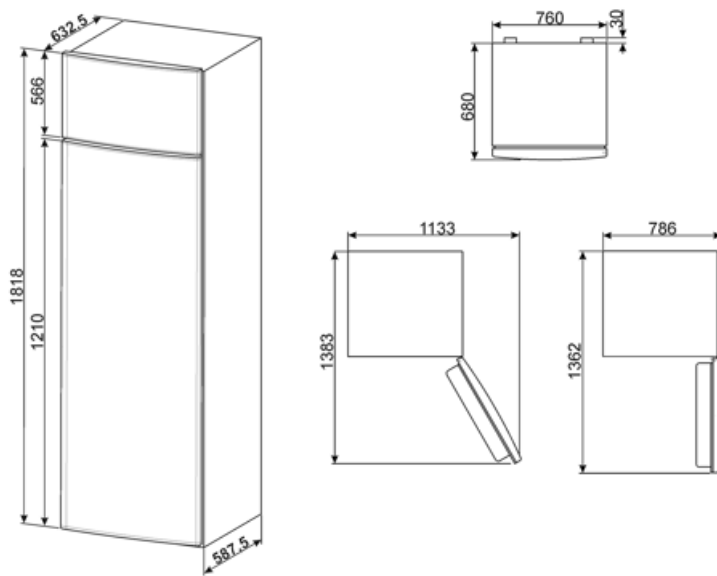

Electrical connection rating	228 W	Frequency (Hz)	50 Hz
Current	1,37 A	Power supply cable length	210 cm
Voltage (V)	220-240 V	Plug	(F;E) Schuko

## Logistic Information

Width	760 mm	Product width with maximum doors opening	1184 mm
Depth without handle	680 mm	Product depth with doors open at 90°	1362 mm
Height	1818 mm	Spacer depth	30 mm



## Symbols glossary

- |  |   |   |  |
|--|---|---|--|
|  | 4 stars freezing compartment for better food preservation.  |  | A+: Energy efficiency class A+ helps to save up to 10% energy compared to class A. Maximum performance with minimum consumption is guaranteed. |
|  | The automatic defrost system works by automatically defrosting at regular intervals eliminating the need to defrost altogether. |  | Fast freezing: The fast freezing function brings the temperature of the compartment down when activated a few hours prior to usage.            |
|  | Fingerprint proof stainless steel: Fingerprint proof stainless steel keeps stainless steel looking as good as new.              |  | LED interior lighting: is a more energy efficient and long lasting way of illuminating the interior of the appliance.                          |
|  | Life Plus 0°C: The temperature in the Lifeplus compartments is kept at 0°C, which preserves fresh meat and fish longer.         |  | Multiflow Cooling System: the Multiflow ventilation system allows an even distribution of cool air around the fridge cabinet.                  |