

## FD70EN4HM



Product Family	Refrigerator
Installation	Free Standing
Category	Double Door
Reference width	60 - 70
Sistema Total No - Frost	Total
Cooling type	Total sem geadá - Sistema de arrefecimento duplo
Defrost	Automatic
Hinge type	Standard
Door opening flush with the wall	No
Slot-in	Yes
Hinge position	Right
Reversible door	Yes
EAN code	8017709295950



## Aesthetics



Aesthetic	Universal	Side material	Steel
Colour	Marble look	Side colour	Cream
Design	Flat	Logotipo	Logotipo aplicado
Material	Metal sheet	Display	LED
Handle kit to be ordered separately	No	Mostrar porções	Externo (na porta)
Handle	External	Dispenser	No
Handle type	Fixed	Water Filter	No
Handle colour	Cream	HomeBar	No
Logo colour	Chrome		

## Refrigerator compartment features



No. of adjustable shelves	2	Bottle shelf	No
Number of fruit and vegetables drawers	2	Type of crisper/vegetable drawers cover	Glass
Type of adjustable shelves	Glass	Life Plus zone-0°C	Yes
Type of crisper/vegetable drawers cover	Standard	Internal light in fridge	Yes
Crisper Cover	Yes	Type of internal light (fridge)	LED

## Refrigerator Inner Door

**Number of adjustable door shelves** 3

**Adjustable door shelves with wire support** No

**No. of bottle shelves** 1

**Bottle shelves with wire support** No

## Other Refrigerator features



**Accessories** Cheese box, Egg tray

**Natural Plus Blu Light** No

**MultiFlow** Yes

**Fan** Yes

## Freezer compartment features

**No. of shelves** 1

**Internal light in freezer** Yes

**Type of internal light (freezer)** LED

**Type of shelves** Glass

## Freezer Inner Door

**No. of adjustable door shelves** 2

**Pizza box** No

## Other Freezer features

**Manual ice maker** Yes

**Ice maker** Manual

**Fast freezing compartment** No

**Ice tray shelf** No

## Other technical features



**Functions display**

Holiday, Fast freezing, Fast cooling, ECO, Control lock, Temperature alarm, Cooling timer

**MultiZone**

No

**Door open alarm**

Yes

**Temperature Alarm**

Yes

**Antibacterial Gasket**

No

**Type of temperature control**

Electronic

**No. of compressors**

1

**Refrigerant gas type**

R600a

**Type of compressor**

Inverter

**Refrigerant Quantity (gr)**

63 g

**Espuma expansiva de isolamento**

Ciclopentano

## Etiqueta de Desempenho / Energia - Reg. 2019







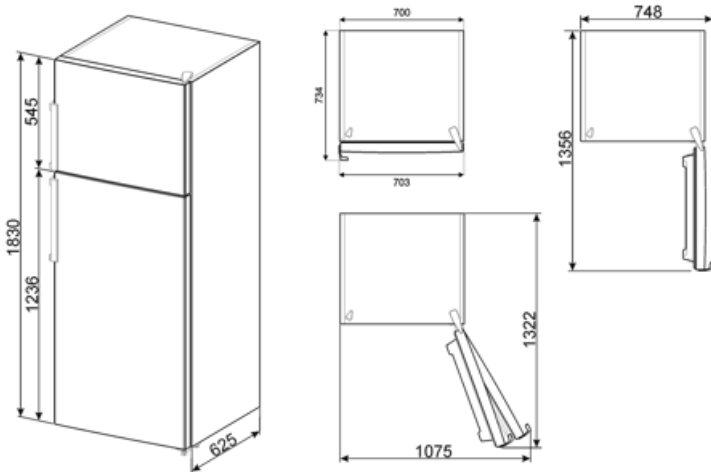







<b>Consumo de energia anual</b>	249 kWh/a	<b>Airborne acoustical noise emissions</b>	41 dB(A) re 1 pW
<b>Classe de eficiência energética</b>	E	<b>Autonomia de conservação sem energia elétrica</b>	13.45 h
<b>Classe de emissão de ruído acústico aerotransportado</b>	C	<b>4 estrelas - Capacidade de congelamento</b>	7.0 Kg/24h
<b>Volume líquido total</b>	434 l	<b>Classe climática</b>	SN, T
<b>Soma dos volumes do(s) compartimento(s) congelado(s)</b>	98 l	<b>EI</b>	100 %
<b>Soma dos volumes do(s) compartimento(s) refrigerado(s) e do(s) compartimento(s) não congelado(s)</b>	337 l		

## Electrical Connection

<b>Plug</b>	(F;E) Schuko	<b>Voltage (V)</b>	220-240 V
<b>Electrical connection rating</b>	200 W	<b>Frequency (Hz)</b>	50 Hz
<b>Current</b>	1.39 A	<b>Power supply cable length</b>	210 cm



## Symbols glossary

-  Compartimento de congelamento de 4 estrelas para uma melhor preservação dos alimentos.
-  Bloqueio para crianças: alguns modelos estão equipados com um dispositivo para bloquear o programa/ciclo para que não possa ser acidentalmente alterado.
-  Classe de eficiência energética E.
-  Modo económico: Analisa o funcionamento da geladeira durante a ativação e otimiza o ciclo de funcionamento, a fim de reduzir o consumo de energia.
-  CONGELAMENTO RÁPIDO: A função de congelamento rápido reduz a temperatura do compartimento quando ativado algumas horas antes do uso.
-  Iluminação interior LED: é uma forma mais eficiente em termos energéticos e duradoura de iluminar o interior do aparelho.
-  Tecnologia do inversor: A evolução dos secadores Smeg para modelos mais inteligentes e ambientalmente sustentáveis levou à escolha do uso da tecnologia do inversor com bombas de calor, o que reduz significativamente o consumo de energia.
-  Slot-in: As geladeiras com abertura Slot-in podem ser perfeitamente integrados na estrutura do mobiliário, uma vez que as portas abertas a 90° não vão além do lado do produto. Em caso de instalação ao lado da parede, será necessário considerar as dimensões do puxador para abrir a porta a 90°.
-  O sistema de descongelamento automático funciona descongelando automaticamente em intervalos regulares, eliminando a necessidade de descongelar completamente.
-  A++: A classe de eficiência energética A++ ajuda a economizar até 20% de energia em comparação com a classe A. O desempenho máximo com consumo mínimo é garantido.
-  Display LED: para mostrar os programas, funções e opções selecionadas e o tempo até ao final do ciclo.
-  Ventilado: Distribuição forçada de ar frio no compartimento da geladeira, o que permite uma distribuição uniforme da temperatura dentro da geladeira.
-  Modo de economia de energia: O modo de economia de energia permite-lhe desativar a geladeira e manter o congelador a funcionar.
-  Life Plus 0°C: A temperatura nos compartimentos Lifeplus é mantida a 0°C, o que preserva a carne fresca e o peixe por mais tempo.
-  Ar mais: mantém a comida mais fresca por mais tempo.

## Benefit (TT)

---

### **No-Frost system**

The No Frost system prevents the formation of ice and contributes to better preservation of food in the refrigerator

### **Plastic multiflow system**

The Multiflow system ensures even distribution of cold air inside the refrigerator

### **Fan**

The fan contributes to an even distribution of air inside the refrigerator

### **Refrigerant gas R600a**

Environmentally friendly R600a refrigerant gas contributes to rapid cooling with lower energy consumption

### **Climate class**

Climatic class SN-T makes the appliance suitable for working at room temperature between 10 °C and 43 °C (50 °F ~ 109 °F)

### **External handle**

The external handle ensures practicality and ease of use of the refrigerator

### **Life Plus 0°**

Temperature-controlled Life Plus compartment for optimal storage of specific food categories

### **Refrigerator Internal lighting**

Interior lighting for perfect visibility of shelves in the refrigerator compartment

### **Freezer internal lighting**

Interior lighting for perfect visibility of the drawers in the freezer compartment

### **Fruit and vegetable drawer**

The fruit and vegetable drawer ensures the best storage conditions for fresh food, avoiding any contamination

### **Inverter compressor**

Inverter compressor reduces noise and vibration levels for a quiet and comfortable kitchen environment

Inverter compressor technology offers significant advantages for refrigeration systems, improving both performance and efficiency. Better temperature control ensures a more stable and constant indoor environment, preserving the freshness of food. This technology also results in reduced energy consumption, as the compressor adjusts its speed according to cooling needs.

### **Manual Ice Maker**

Manual ice maker to manually adjust the amount of ice produced according to personal requirements

---

## External display

External display for simple and intuitive control with quick access to information